

Molteni & C

LIA — GAMFRATESI 2025

1—
2



The conceptual and technical research behind this armchair focuses on lightness. Its oak wood structure, combined with a seat suspended between two ends and supported by a light yet solid metal frame, expresses a unique synthesis of aesthetics and technical craftsmanship.



This symbol shows that the product has removable upholstery. Only qualified personnel can remove the upholstery of some of our products. If this information is pertinent, it will be included in the warnings section.



This symbol shows that the product is available on request in a fire resistant version that complies with the standards BS 5852 and TB 117-2013. The buyer is responsible for checking to make sure that the product is suitable and compliant with the requirements for the designated use and the current applicable laws and standards for the destination and use of the product.

DATASHEET

REGISTERED
DESIGN

2025

moltenigroup.com

Dimensions in centimeters and inches. The right to discontinue and make changes is reserved. This information is based on the latest product information available at the time of printing.

FINISHES

BASE FINISH
anthracite

ARMRESTS /
PERIMETER FRAME FINISH
coffee oak

Molteni & C

2—
2

TECHNICAL INFORMATION

BASE
Anthracite painted metal structure.

SEAT INTERIOR
Load-bearing metal frame with elastic straps on the seat.

SEAT PADDING
Cold-moulded polyurethane foam and cotton/polyester fibre cover.

ARMRESTS AND PERIMETER FRAME
In stained solid ash wood (Fraxinus excelsior).

FEET
Plastic material.

REMOVABLE OUTER COVER
(See attached card, specifically for the cover).



AVAILABLE IN FIRE-RESISTANT
VERSION TB117 AND BS5852

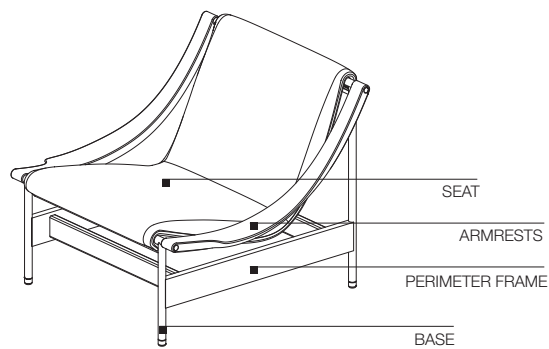

DIMENSIONS

armchair

LPL1

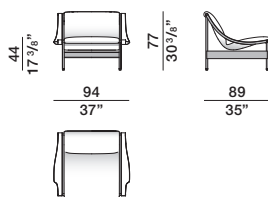

DATASHEET

REGISTERED
DESIGN

2025