

# Molteni & C

## TURNER — HANNES WETTSTEIN 2008

1—  
5



Formal moment or relaxing space? Turner, the seating system designed by Hannes Wettstein, combines comfort with refinement. Settees in various sizes, corner pieces, chaises-longue and pouf can be combined together to create different furnishing solutions. Turner responds to varying needs in terms of comfort and posture, thanks to an easy mechanism which adjusts the depth of the seating.

### DATASHEET

REGISTERED  
DESIGN

IX.2018

## FINISHES

### COVERS

fabric - leather, completely removable.  
The seating cushions are not reversible.

### FEET FINISH

shiny aluminium

Available in fire-resistant version (TB117 and BS5852).

## TECHNICAL INFORMATION

### STRUCTURE INTERIOR

Frame made of solid fir (*Picea abies*) and chipboard, with elastic straps.

### STRUCTURE PADDING

High capacity variable density foam polyurethane. Light velvet cover.

### SEAT CUSHIONS

Insert in shaped polyurethane and sterilised feathers. 100% cotton cover.

### BACK CUSHIONS

Polyurethane flakes and sterilised down feathers in compartments. 100% cotton cover.

### FRAME

Painted metal with feet in non-slip plastic.

### FEET

Extruded aluminium, anodised or painted.

### REMOVABLE OUTER COVERS

(See attached card, specific for each cover).

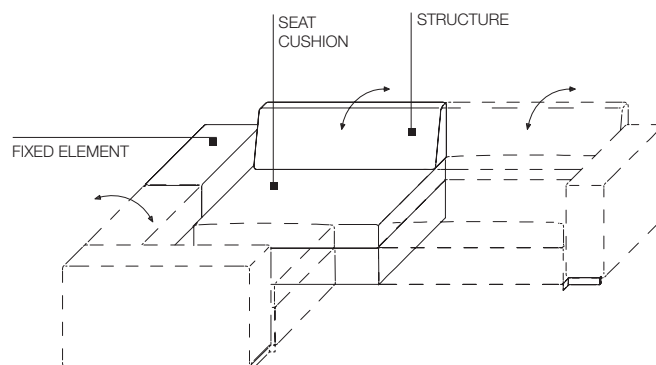
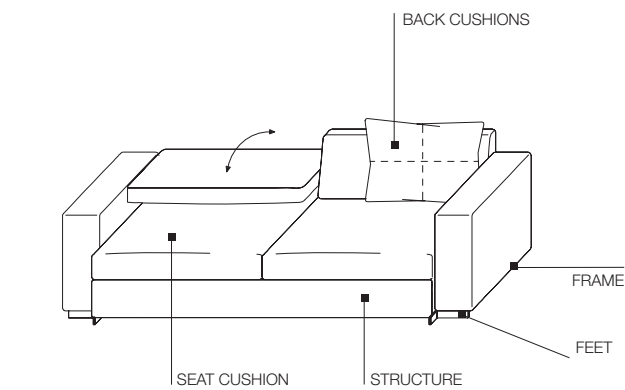

## DATASHEET

REGISTERED  
DESIGN

IX.2018

## DIMENSIONS

### End units, central units, chaise longues and islands

Elements **cannot be used individually.**

All elements have back with mechanism.

**The compositions are always closed at the side with an arm.**

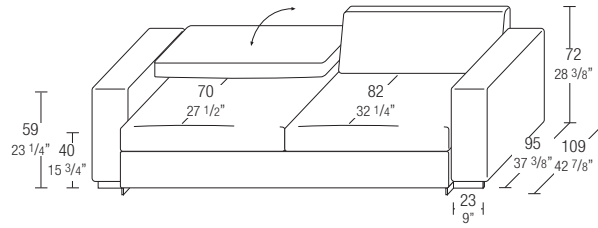

## Molteni & C

### Corner

The corner element **cannot be used alone** but must be placed by a central or terminal element, on the opposite side to the arm. The corner element comes with mechanism only on the long side.

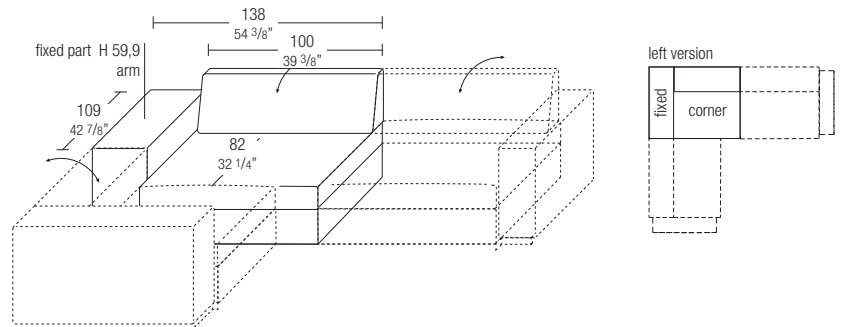

## DIMENSIONS

### Notes

- Each single element (terminal, central, corner, chaise longue or island) must be completed, in the interests of ergonomic quality, with one or more back cushions to choose from: TCS60 - TCS70 - TCS80.

Molteni & C

4—  
5

#### end element

##### T108 dx - sx

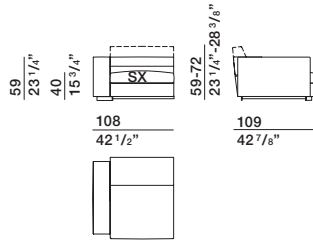

##### T123 dx - sx

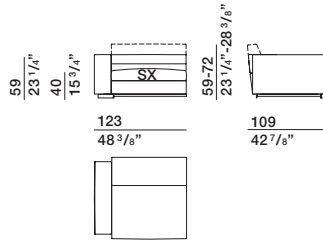

##### T143 dx - sx

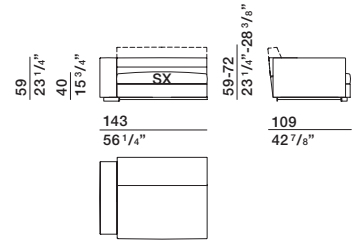

#### central

##### CE85

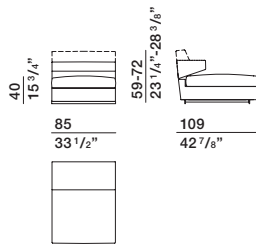

##### CE100

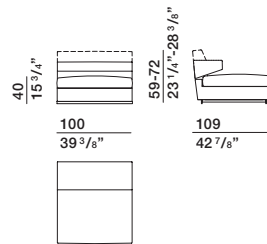

##### CE120

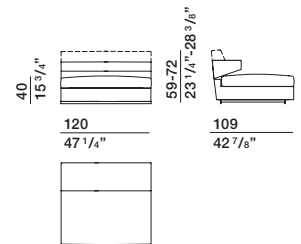

#### chaise longue

##### CL108 dx - sx

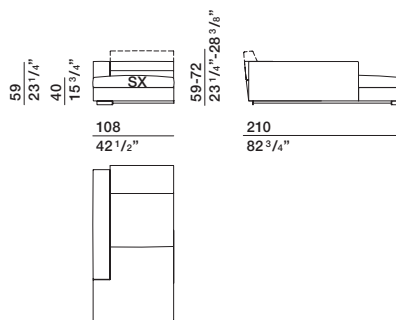

##### CL123 dx - sx

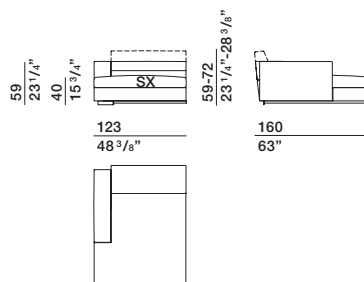

#### island

##### IS108 dx - sx

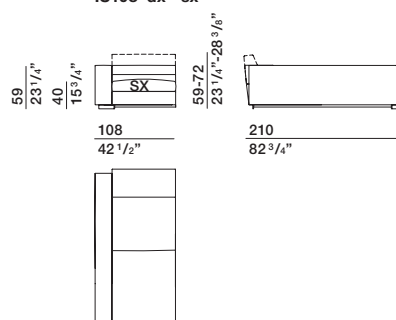

##### IS123 dx - sx

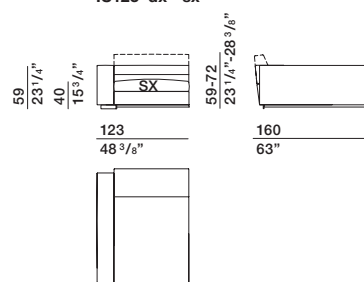

DATASHEET

REGISTERED  
DESIGN

IX.2018

**DIMENSIONS**

**island**

**IS143 dx - sx**

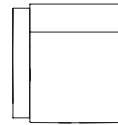
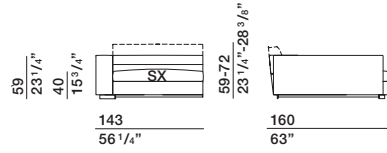

**corner**

**AN138 dx - sx**

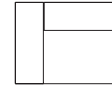
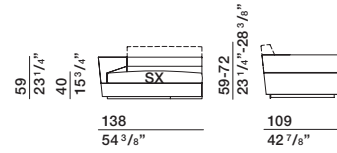

**Molteni & C**

5—  
5

**pouf**

**PF100**

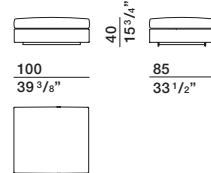

**PF108**

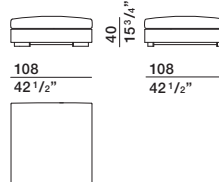

**PF120**

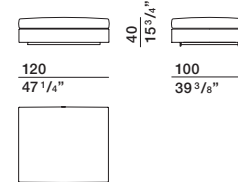

**pair of  
extra cushions  
CCQ/50**

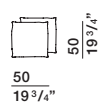

**back cushions**

**TCS60**

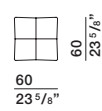

**TCS70**

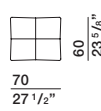

**TCS80**

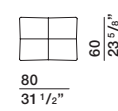

**SAMPLE COMPOSITIONS**

**composition 4**

**TC04**

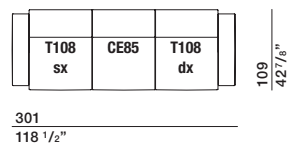

**composition 10**

**TC10**

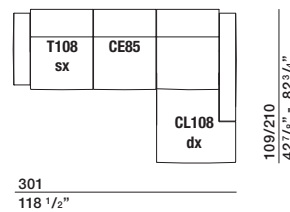

**DATASHEET**

REGISTERED  
DESIGN

IX.2018