

Molteni & C

ALBERT — VINCENT VAN DUYSSEN 2018

1—
3



Albert is a world that reflects a personality, a complete programme of elements to model into configurations that are always diverse and modifiable, a dynamic system with rigorous geometric elements that make up an original interplay of soft volumes following a customisable scheme. By putting together the different elements and playing on the alternations of chairs and ottomans, an original and extremely complete configuration develops, able to present soft welcoming domestic islands that are ideal for spending a little free time or enjoying a complete relaxation. Double backrest cushioning: the traditional “backrest cushion” is combined with an elegant quilted back cushion to support the shoulders in the relaxing configuration, or to reduce the depth of the seat in conversation mode. Albert gives a contemporary interpretation to the living room by placing an accent on elegance, functionality and comfort, keeping attention focused on particulars and attention to details. A complete, calibrated collection with surprising aesthetic equilibrium, refined elegance and versatility.

DATASHEET

REGISTERED
DESIGN

IX.2019

FINISHES

COVERS

Covers are completely removable, both for fabric and leather versions.

Pouf covers can be removed by expert personnel.

The profile that defines the perimeter of the structure cover is always made with a charcoal coloured binding for all versions and all colours of fabric and leather.

Available in fire-resistant version (TB117 and BS5852).

BASE FINISHES

pewter colour

Molteni & C

TECHNICAL INFORMATION

STRUCTURE INTERIOR

Frame made of solid Fir (Picea abies) and chipboard, with elastic straps.

STRUCTURE PADDING

High capacity variable density foam polyurethane. Light velvet cover.

SEAT CUSHION

Insert in shaped polyurethane and sterilised feathers. 100% cotton cover.

BACKREST CUSHIONS

Polyester fibre, sterilised feathers. 100% cotton cover.

BACK CUSHIONS

Panel in wood particles with edging in shaped polyurethane and polyester fibre. 100% cotton cover.

BASE

Anodised aluminium in pewter colour set on plastic floor slides.

REMOVABLE OUTER COVER

(See attached card, specifically for the cover).

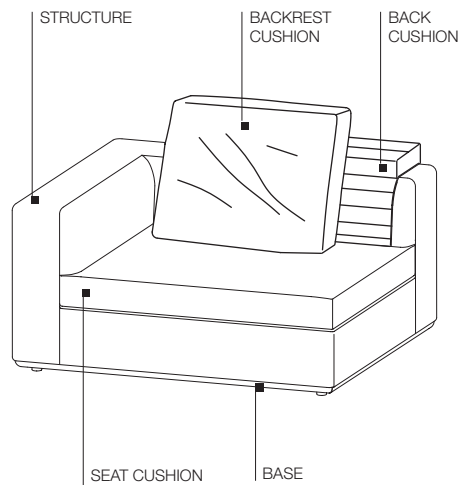

DATASHEET

REGISTERED
DESIGN

IX.2019

DIMENSIONS

end element

TR1210 dx-sx

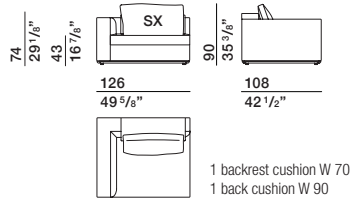

TR1910 dx-sx

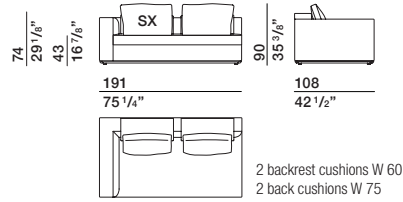

central element

CE1010

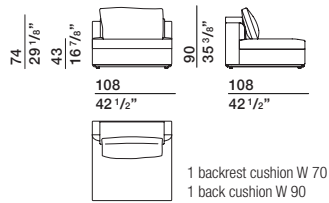

CE1310

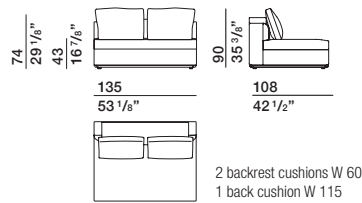

CE1710

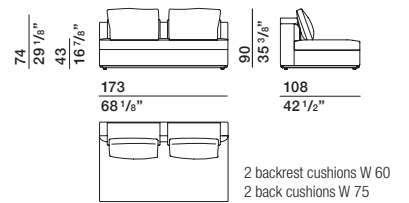

chaise longue

CH1015

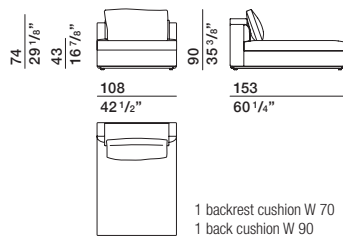

CH1215 dx-sx

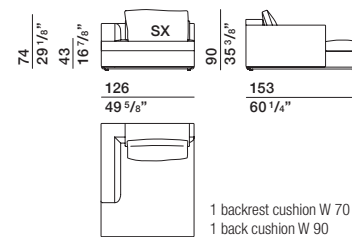

CH1315 dx-sx

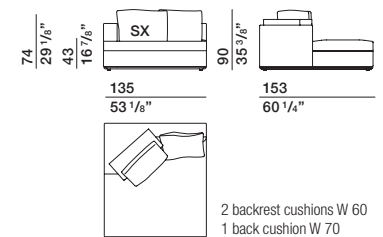

island element

IS2110 dx-sx

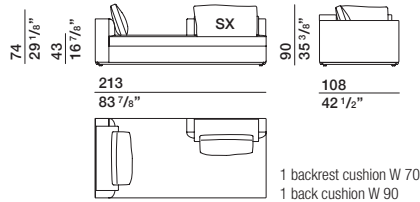

pouf

PO1073

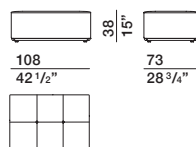

PO1010

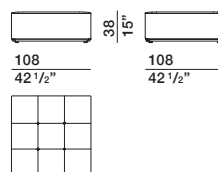

PO1310

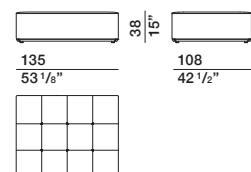

DATASHEET

REGISTERED
DESIGN

IX.2019