

Molteni & C

FILIGREE — RODOLFO DORDONI 2013

1—
3

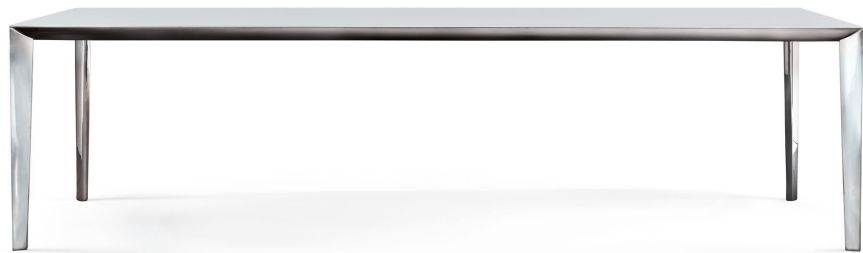

Filigree is a range of fixed size and extension tables. The technology used in the discreet Filigree main element allows an extendable table with an invisible lateral telescopic system. The entire top is without cuts, and extends to double its size. It allows the maximum use of space thanks to the outer legs, minimum thickness of the tops, and above all its mechanism containment structure and extensions which are only 38 mm internal thickness. The tables are available in different materials and finishes to meet all needs.

DATASHEET

REGISTERED
DESIGN

IX.2022

FINISHES

EXTENDABLE TABLE TOP FINISHES

woods (eucalyptus, thermo oak, graphite oak)

FIXED TABLE TOP FINISHES

woods (eucalyptus, thermo oak, graphite oak)

coloured glass in the Molteni colour range

etched coloured glass in the Molteni colour range

black marquina marble

emperador dark marble

white Carrara marble

orient grey marble

green alpine marble

silver wave marble

Sahara noir marble

calacatta gold marble

STRUCTURE FINISHES

black nickel - pewter colour (satin finish) - eucalyptus (only for fixed tables)

NOTES

With eucalyptus structures, the wooden shelf will always be in the same finish as the structure.

TECHNICAL INFORMATION

FIXED TABLE STRUCTURE

Aluminium extrusion anodised, painted or clad with sliced Eucalyptus wood, with internal metal frame and laminated struts.

EXTENDABLE TABLE STRUCTURE

Anodised extruded aluminium with internal metal frame and runners on extruded aluminium tracks. Telescopic cover profile of the extendable table in extruded plastic.

GLASS TOP

Transparent or etched extra light glass, tempered, th. 6 mm, painted in colours in the Molteni range.

WOOD TOP AND EXTENSIONS

Composite panel of medium density fibre and aluminium sheets, th. 1mm, covered in Oak (*Quercus*), Walnut (*Juglans nigra*) or Eucalyptus (*Eucalyptus globulus*) veneer.

MARBLE TOP

Marble in Range finishes with anti-stain, water-repellent treatments.

FIXED TABLE BASE

Wood particleboard panel with painted melamine facing.

EXTENDABLE TABLE BASE

Medium density fibre composite panel with external surface in anodised aluminium sheet, th. 1mm.

LEG

In die cast aluminium shiny brushed, chromed, painted or clad in sliced Eucalyptus wood. Internal metal brace and foot in non-slip plastic.

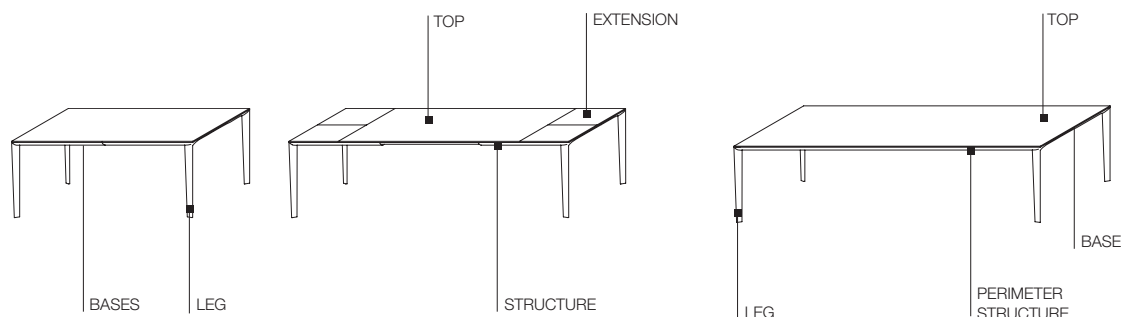

DATASHEET

REGISTERED
DESIGN

IX.2022

DIMENSIONS

extendable rectangular table

FTA18/10 closed

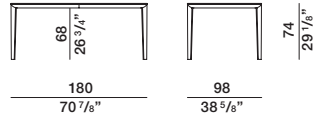

black nickel/
 pewter colour
 structure

FTA18/10 partially open

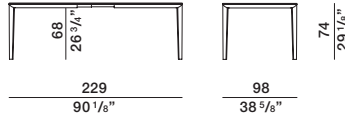

black nickel/
 pewter colour
 structure

FTA18/10 fully open

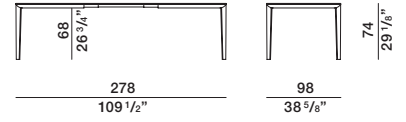

black nickel/
 pewter colour
 structure

fixed rectangular tables

FTF18/10

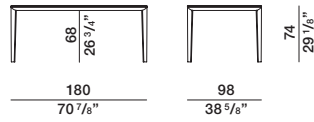

black nickel/ eucalyptus
 pewter colour structure
 structure

FTF21/10

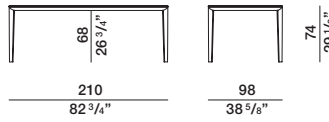

black nickel/ eucalyptus
 pewter colour structure
 structure

FTF24/10

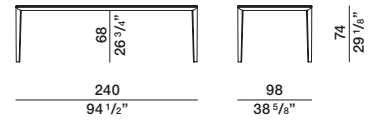

black nickel/ eucalyptus
 pewter colour structure
 structure

fixed rectangular table

FTF28/12

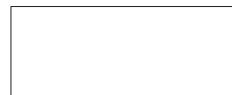
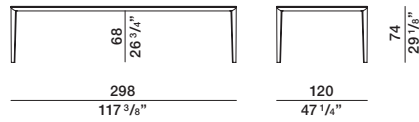

black nickel/ eucalyptus
 pewter colour structure
 structure

DATASHEET

REGISTERED
 DESIGN

IX.2022