

Molteni & C

D.156.3 ARMCHAIR — GIO PONTI 1956 / 2017

1—
2



Designed by Gio Ponti and produced for Altamira, an American company founded by the nephew of the Spaniard De Cuevas, was displayed in the company's showroom in New York, along with furniture by Ico Parisi, Franco Albini, Carlo De Carli, Ignazio Gardella and others, chosen from among the most representative exhibitors at the 10th Milan Triennale. The D.156.3 armchair, exclusively remade by Molteni&C, has a solid American walnut or black semi-matt lacquered frame. It is assembled and sandpapered by hand.

DATASHEET

REGISTERED
DESIGN

IX.2020



This symbol shows that the product is available on request in a fire resistant version that complies with the standards BS 5852 and TB 117-2013.

The buyer is responsible for checking to make sure that the product is suitable and compliant with the requirements for the designated use and the current applicable laws and standards for the destination and use of the product.

D.156.3
ARMCHAIR –
GIO PONTI
1956 / 2017

FINISHES

NOTES

Cushion with NON removable cover.

Black and hunter green stucture straps.

STRUCTURE FINISHES

glossy black lacquered solid wood

solid American walnut

Molteni & C

2—
2

TECHNICAL INFORMATION

- STRUCTURE IN SOLID MAPLE WITH GLOSSY BLACK FINISH AND IN SOLID AMERICAN WALNUT FOR THE NATURAL WOOD FINISH;
- IT IS ASSEMBLED AND SANDPAPERED BY HAND;
- IT IS WIPED WITH ANILINE DYES;
- ELASTIC ERGONOMIC SEAT AND BACK SUPPORT BANDS IN THE COLOURS BLACK AND MILITARY GREEN, SELECTED BY THE CLIENT;
- REMOVABLE QUILTED CUSHION IN POLYURETHANE AND POLYESTER FIBRE;
- UPHOLSTERY IS NON-REMOVABLE.



AVAILABLE IN FIRE-RESISTANT
VERSION TB117 AND BSS852

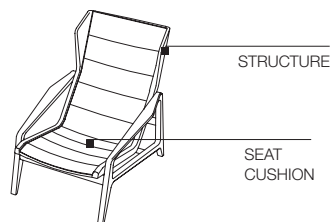

DIMENSIONS

armchair

D.156.3

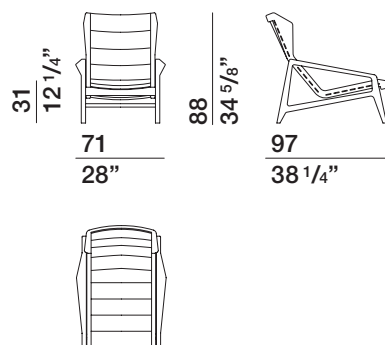

DATASHEET

REGISTERED
DESIGN

IX.2020

moltenigroup.com

Dimensions in centimeters and inches. The right to discontinue and make changes is reserved. This information is based on the latest product information available at the time of printing.