

# Molteni & C

## BELGRAVIA — RODOLFO DORDONI 2018

1—  
3



Belgravia, the aristocratic district of London with its impressive Victorian mansions, inspired this family of tables with their refined fluid shapes. A bridge-shaped wooden frame, with a double inclination outline and a sophisticated joinery technique, enables the legs and the load-bearing beam of the table to be joined. The tops in the three noble materials of stone, wood and glass, enrich the whole, creating great design continuity. Different dimensions allow the tables to be used in a variety of settings where Belgravia will always be the undisputed protagonist.

### DATASHEET

REGISTERED  
DESIGN

IX.2020

## FINISHES

STRUCTURE FINISHES  
(LATERAL PARTS AND LEGS)  
eucalyptus  
graphite oak

TOP FINISHES  
**Wood:**  
eucalyptus  
graphite oak

COLOURED GLASS:  
in the colours from  
the Molteni range

TOP FINISHES  
**Glossy marble:**  
emperador dark  
orient grey  
calacatta gold

# Molteni & C

2—  
3

## TECHNICAL INFORMATION

### BRIDGE-SHAPED FRAME

Medium density layered fiber panel, solid beech wood (*fagus silvatica*), formed and covered with sliced veneer in Eucalyptus (*Eucalyptus globulus*) and Oak (*Quercus*).  
Additional corner piece in aluminum, feet in plastic material with felt supports.

### CENTRAL FRAME

Tubular iron with epoxy coating and top adjustment system.

### WOOD TOP

Wood particle board paneling covered with sliced veneer in Eucalyptus or Oak.

### GLASS TOP

Support in wood particle board paneling with melamine finish.  
Transparent tempered glass, thickness 4 painted in colors from the range.  
Head profile in painted extruded aluminum.

### MARBLE TOP

Marble with protective mesh in the finishes from the range.

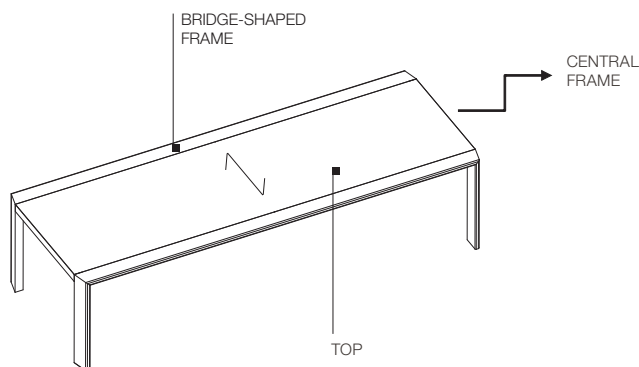

## DATASHEET

REGISTERED  
DESIGN

IX.2020

**DIMENSIONS**

**Notes**

- ▶ No reductions of any kind are possible.
- ▶ In the version with marble top, the top is always divided in the middle.
- ▶ In the wood version, the grain of the top is transversal and the strips are lengthwise.
- ▶ In the glass version the heads are in pewter colour painted finish.

**table**

**BT21/11**

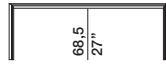

210  
82 5/8"

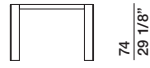

106  
41 3/4"

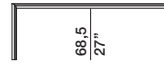

210  
82 5/8"

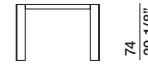

106  
41 3/4"

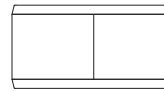
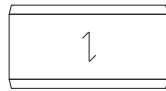

marble top version

**table**

**BT24/11**

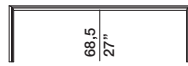

240  
94 1/2"

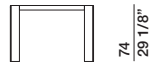

106  
41 3/4"

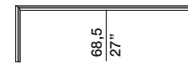

240  
94 1/2"

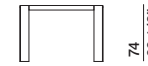

106  
41 3/4"

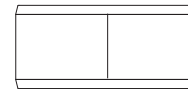
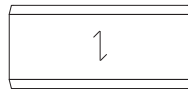

marble top version

**table**

**BT30/11**

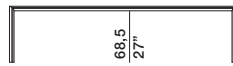

300  
118 1/8"

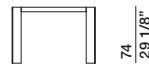

106  
41 3/4"

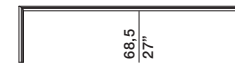

300  
118 1/8"

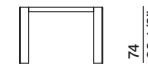

106  
41 3/4"

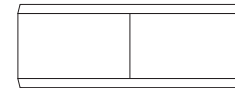
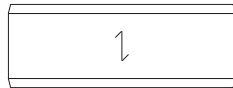

marble top version

**table**

**BT16/16**

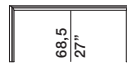

160  
63"

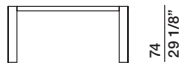

160  
63"

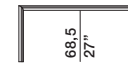

160  
63"



160  
63"

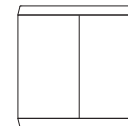
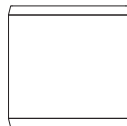

marble top version

**DATASHEET**

REGISTERED  
 DESIGN

IX.2020