

Molteni & C

4040 — DANTE BONUCCELLI 2015

1—
2



4040 is a generously proportioned bedside unit and an ideal companion for the wide range of beds offered by Molteni&C. Framework and drawers are made of essence and rest on a pewter-coloured metal base. The top can be in essence or marble. A wooden bedside unit with two drawers with a pressure opening. It is available in two variants in all wood or wood with marble top.

DATASHEET

REGISTERED
DESIGN

IX.2020

FINISHES

BASE FINISH
pewter colour

MARBLE FINISHES

emperador dark - black marquina - white Carrara - orient grey - silver dune - silver wave - green alpine

WOODEN FINISHES

eucalyptus - grey oak - graphite oak

Molteni & C

2—
2

TECHNICAL INFORMATION

CURVED STRUCTURE AND DRAWER FRONT

Curved, molded laminated poplar (*Populus alba*) panel, clad with sliced Eucalyptus (*Eucalyptus globulus*) or Oak (*Quercus*) wood.

SIDES AND BOTTOM - DRAWER INTERIOR

Laminated poplar panel clad with sliced Eucalyptus or Oak wood.

BASE

In painted metal.

UPPER WOOD TOP

Medium density fibre panel clad with sliced Eucalyptus or Oak wood.

UPPER MARBLE TOP

Marble in Range finishes with anti-stain, water-repellent treatments.

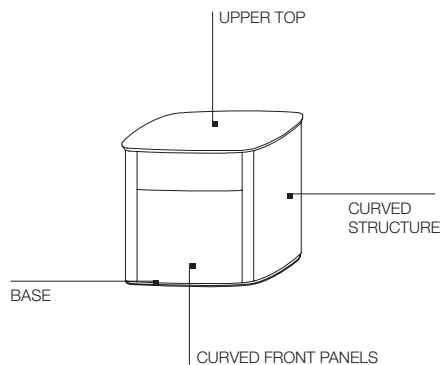

DIMENSIONS

night table
all in wood

QCP1

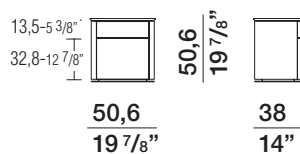

wooden night table
with top in marble

QCP1M

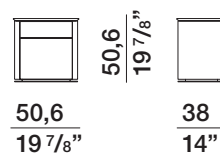

DATASHEET

REGISTERED
DESIGN

IX.2020