

Molteni & C

606 — RODOLFO DORDONI 2010

1—
3



A range of drawer units distinguished by a clean and elegant design, characterized by the handle-free front. 606 is available either with a floor standing base or supported by a metal frame. Thanks to its wide range of finishes, 606 is a versatile product easily fitting to any furnishing ambience.

DATASHEET

REGISTERED
DESIGN

IX.2020

FINISHES

DRAWER UNIT FINISHES

matt lacquer colours in the Molteni colour range - eucalyptus - grey oak - graphite oak

GLASS TOP FINISH

coloured etched glass in the Molteni colour range

FLOOR STANDING BASE FINISH

anthracite

METAL FRAME FINISH

shiny chrome - black chrome

Molteni & C

2—
3

TECHNICAL INFORMATION

INTERNAL STRUCTURE

Particleboard panel, coated with melamine resin.

EXTERNAL AND FRONT FINISH (MATT LACQUERED VERSION)

Particleboard panel, coated with melamine resin and painted in shades from the “Molteni Range”.

EXTERNAL AND FRONT FINISH (WOOD VERSION)

Particleboard panel veneered with sliced Oak (*Quercus*) or Eucalyptus (*Eucalyptus globulus*).

FRAME

In chrome plated steel.

GLASS TOP

Glass (th. 8 mm), tempered, etched and coloured with the colours in the “Molteni Range”.

SPACER

MDF panel with wood veneer in Oak, Eucalyptus or with melamine paper facing painted in the “Molteni Range” colours.

SIDES AND INTERNAL DRAWER BOTTOM

Particleboard panel, coated with melamine resin.

ADJUSTABLE FEET

Non-skid plastic material.

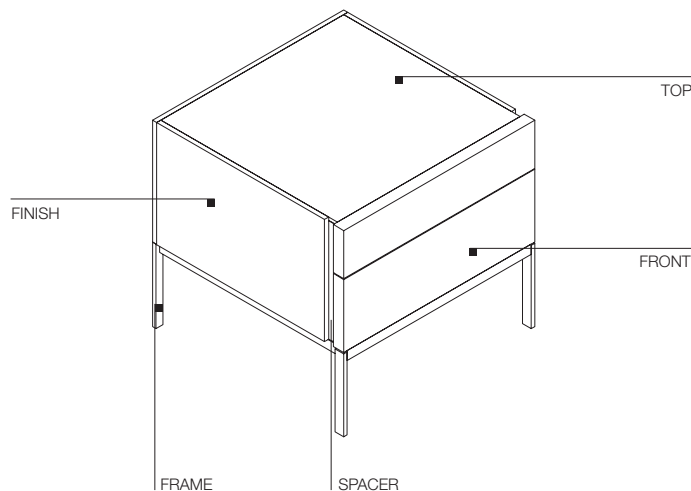

DATASHEET

REGISTERED
DESIGN

IX.2020

DIMENSIONS

Notes

- ▶ The drawer units in matt lacquer can be fitted, on request, with a spacer in between structure and front in a different colour than the drawer unit itself.
- ▶ Standard version comes with partially extractable runners. Fully extractable runners have a surcharge per drawer.

bedside unit with 2 drawers

SCZ2

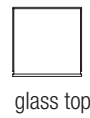
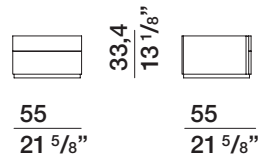

drawer unit with 4 drawers

SCZ4

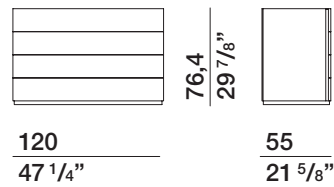

drawer unit with 7 drawers

SCZ5

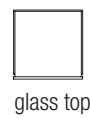
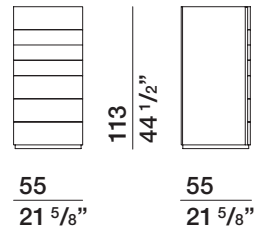

bedside unit with 2 drawers

SCC2

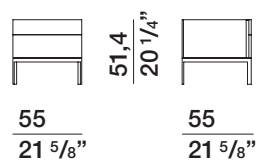

drawer unit with 3 drawers

SCC3

