

Molteni & C

ALBERT — VINCENT VAN DUYSSEN 2018

1—
4



The new seating system reflects the Molteni&C corporate profile, based on two key words: tradition and technology, linked by the leitmotif of perfectly clean lines. A flexible and dynamic seating system, rich in content, which shows how research and craftsmanship have always been part and parcel of the company's DNA. Albert is a brave step forward in the search for a seating system conceived as a flexible and disarticulatable structure, that can reshape the new complexity of modern living, marked by extreme planning.



This symbol shows that the product has removable upholstery. Only qualified personnel can remove the upholstery of some of our products. If this information is pertinent, it will be included in the warnings section.



This symbol shows that the product is available on request in a fire resistant version that complies with the standards BS 5852 and TB 117-2013. The buyer is responsible for checking to make sure that the product is suitable and compliant with the requirements for the designated use and the current applicable laws and standards for the destination and use of the product.

DATASHEET

REGISTERED
DESIGN

IX.2021

moltenigroup.com

Dimensions in centimeters and inches. The right to discontinue and make changes is reserved. This information is based on the latest product information available at the time of printing.

FINISHES

COVERS

- ▶ **Pouf covers can be removed by expert personnel.**
- ▶ The profile that defines the perimeter of the structure cover is always made with a charcoal coloured binding for all versions and all colours of fabric and leather.

BASE FINISHES

pewter colour

Molteni & C

TECHNICAL INFORMATION

STRUCTURE INTERIOR

Frame made of solid Fir (Picea abies) and chipboard, with elastic straps.

STRUCTURE PADDING

High capacity variable density foam polyurethane. Light velvet cover.

SEAT CUSHION

Insert in shaped polyurethane and sterilised feathers. 100% cotton cover.

BACKREST CUSHIONS

Polyester fibre, sterilised feathers. 100% cotton cover.

BACK CUSHIONS

Panel in wood particles with edging in shaped polyurethane and polyester fibre. 100% cotton cover.

BASE

Anodised aluminium in pewter colour set on plastic floor slides.

REMOVABLE OUTER COVER

(See attached card, specifically for the cover).



AVAILABLE IN FIRE-RESISTANT
VERSION TB117 AND BS5852

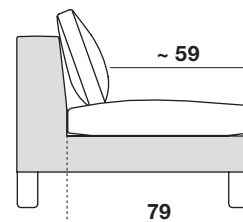
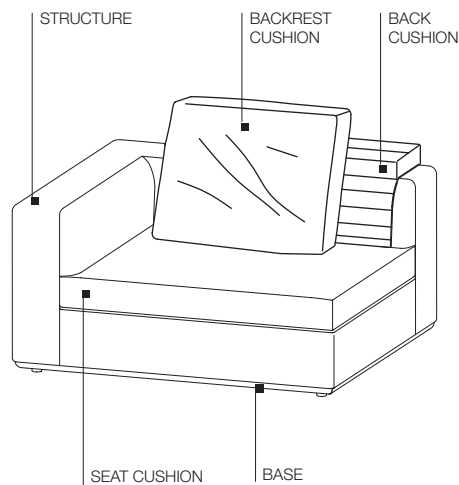

Seat depth for structure only, 79 cm
Seat depth with backrest cushion, ~ 59 cm

DATASHEET

REGISTERED
DESIGN

IX.2021

DIMENSIONS

end element

TR1210 dx-sx

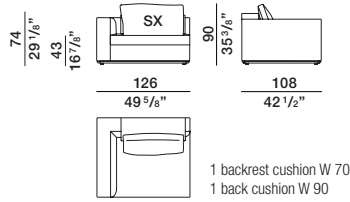

TR1910 dx-sx

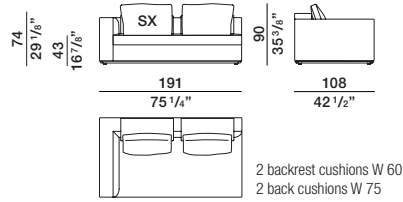

central element

CE1010

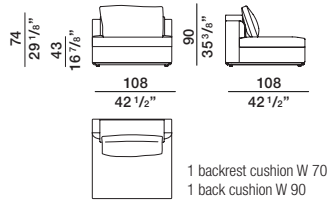

CE1310

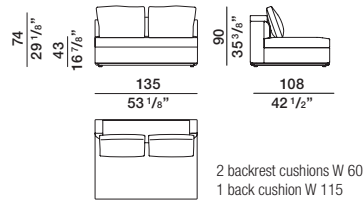

CE1710

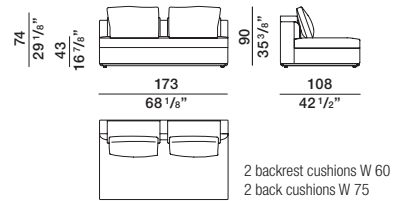

chaise longue

CH1015

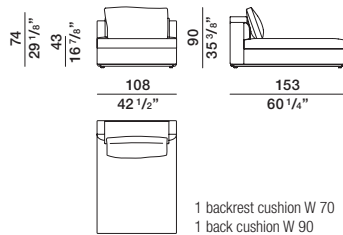

CH1215 dx-sx

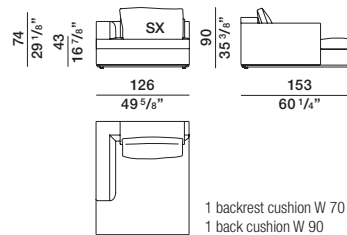

CH1315 dx-sx

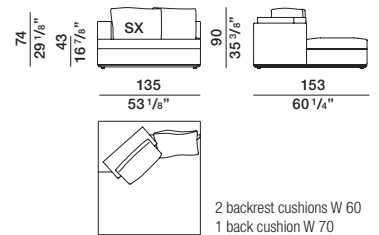

island element

IS2110 dx-sx

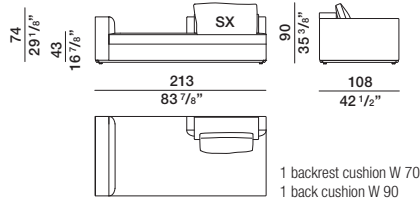

backrest cushion

CSH70



backrest cushion

CSH60



pouf

PO1073

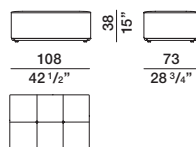

PO1010

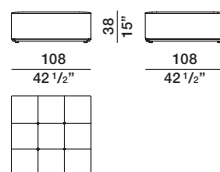

PO1310

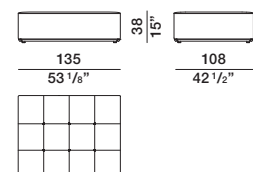

DATASHEET

REGISTERED
DESIGN

IX.2021

ALBERT—
VINCENT
VAN DUYSSEN
2018

code	gross weight kg.	volume mc.	packages	code	gross weight kg.	volume mc.	packages
CE1010	55	1,051	1	IS2110	97	1,906	1
CE1310	66	1,221	1	PO1010	39,5	0,691	1
CE1710	81	2,646	1	PO1073	31	0,509	1
CH1015	65	1,073	1	PO1310	46	0,85	1
CH1215	88	1,878	1	TR1210	73	1,183	1
CH1315	94	2,012	1	TR1910	98	1,755	1

Molteni & C

4—
4

DATASHEET

REGISTERED
DESIGN

IX.2021

moltenigroup.com

Dimensions in centimeters and inches. The right to discontinue and make changes is reserved. This information is based on the latest product information available at the time of printing.