

Molteni & C

D.153.1 ARMCHAIR — GIO PONTI 1953 / 2012

1—
2



Designed in 1953, the D.153.1 armchair is part of the furniture of Gio Ponti's private house in via Dezza in Milan. Brass structure, cover in two-coloured leather or "Punteggiato" fabric, designed by Ponti for Rubelli in 1934. The fabric reinterprets the age-old technique of velvet-weaving, bringing it up to date with contemporary patterns, such as close sequences of staggered disks with various gradations of colour. Exhibited at the Salone del Mobile 2012, the D.153.1 chair enriches the Gio Ponti furnishing Collection.



This symbol shows that the product has removable upholstery. Only qualified personnel can remove the upholstery of some of our products. If this information is pertinent, it will be included in the warnings section.



This symbol shows that the product is available on request in a fire resistant version that complies with the standards BS 5852 and TB 117-2013. The buyer is responsible for checking to make sure that the product is suitable and compliant with the requirements for the designated use and the current applicable laws and standards for the destination and use of the product.

DATASHEET

REGISTERED
DESIGN

IX.2021

D.153.1
ARMCHAIR –
GIO PONTI
1953 / 2012

FINISHES

Made with brass frame.

Covers in:

Two-coloured leather:

- white L212 / blue L100
- paper white S1211 / sand S1222
- dove grey L209 / dark brown L216

“Punteggiato” velvet in colours from the Molteni Collection range.

Fabrics and leathers from the Molteni Collection range (see table of combinations in the Sofas price list).

NOTES

Armchair cover can be removed by expert personnel.

Molteni & C

TECHNICAL INFORMATION

UPHOLSTERED STRUCTURE

Frame in solid Fir (Picea abies) with elastic straps, covered in custom polyurethane in different thicknesses. Bonded velveteen lining.

ARMREST

In solid Fir covered in custom polyurethane. Bonded velveteen lining.

LEGS

In heat-sealed steel with a satin brass finish. Feet in non-slip plastic.

OUTER COVER

(See attached card, specific for each cover).

Note: Covers are difficult to remove.



OUTER COVER
REMOVABLE BY
EXPERT PERSONNEL



AVAILABLE IN FIRE-RESISTANT
VERSION TB117 AND BS5852

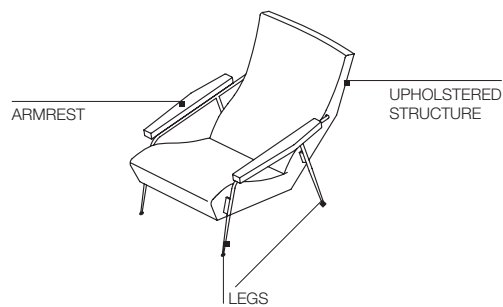

DIMENSIONS

armchair

D.153.1

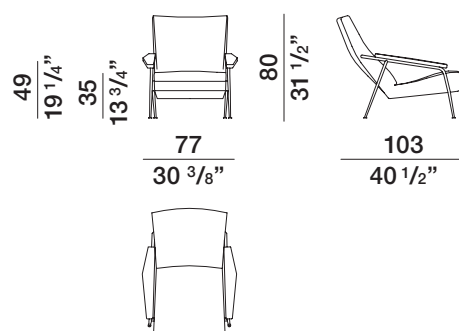

DATASHEET

REGISTERED
DESIGN

IX.2021

moltenigroup.com

Dimensions in centimeters and inches. The right to discontinue and make changes is reserved. This information is based on the latest product information available at the time of printing.