

Molteni & C

WISH — RODOLFO DORDONI 2009

1—
4



Wish is the best example of the use of wood and attention given to details to create a timeless classic. A bed in solid wood with minimal, refined lines, comes with soft pillows, in fabric or in leather, which combine with the solid wood of the headboard.

In case of customer slatted base and/or mattress, check the correspondence of the measurements with the standard ones in the price list.



This symbol shows that the product has removable upholstery. Only qualified personnel can remove the upholstery of some of our products. If this information is pertinent, it will be included in the warnings section.



This symbol shows that the product is available on request in a fire resistant version that complies with the standards BS 5852 and TB 117-2013. The buyer is responsible for checking to make sure that the product is suitable and compliant with the requirements for the designated use and the current applicable laws and standards for the destination and use of the product.

DATASHEET

REGISTERED
DESIGN

IX.2022

moltenigroup.com

Dimensions in centimeters and inches. The right to discontinue and make changes is reserved. This information is based on the latest product information available at the time of printing.

FINISHES

WOODEN STRUCTURE FINISHES

graphite oak - black oak - eucalyptus

TECHNICAL INFORMATION

HEADBOARD AND FEET

In solid Oak (Quercus) with felt non-slip grips on feet. The Eucalyptus version is American walnut (Juglans nigra) tinted.

EDGE RUNNERS

Panel in birch (Betula alba) listels covered in sliced Oak or American walnut wood tinted Eucalyptus.

UPPER BANDS

Panel in birch veneer covered in sliced Oak or American walnut wood tinted Eucalyptus.

HEADBOARD CUSHIONS

Insert in foam rubber and sterilised down. Cover 100% cotton. Rest on panels in wood chip covered in sliced Oak wood.

REMOVABLE OUTER COVERS

(See attached label, specific for each cover).

ADJUSTABLE BASE SUPPORT

Tropicalised metal with soft PVC cover.

CENTRAL BASE SUPPORT (OPTIONAL)

Painted metal.



AVAILABLE IN FIRE-RESISTANT
VERSION TB117 AND BS5852

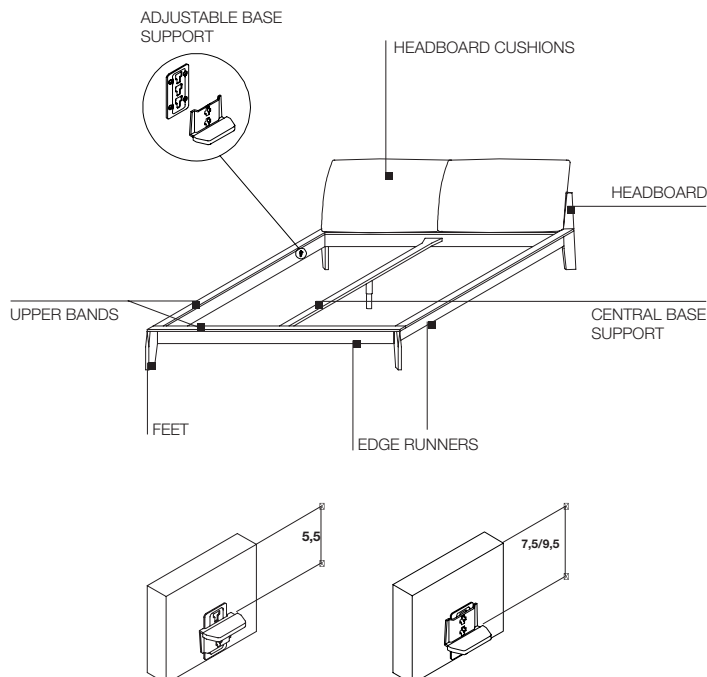

DATASHEET

REGISTERED
DESIGN

IX.2022

DIMENSIONS

Notes

Depth of 210 cm (82 3/4") (inner measurement) is also available on WLE16 - WLE17 - WLE18.

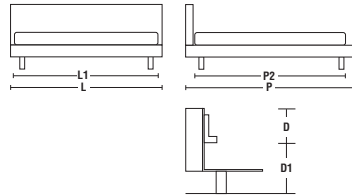

	INNER DIMENSIONS		OUTER DIMENSIONS		D / D1 Space for insertion of the slatted base
	L1 Width	P2 Length	L Width	P Length	
WLE16	160 63"	200 78 3/4" <small>standard model *</small>	180 70 7/8"	231 91" <small>standard model *</small>	5,5 / 26,5 <small>2 1/8" / 10 3/8"</small>
WLE17	170 66 7/8"	2000 78 3/4" <small>standard model *</small>	190 74 3/4"	231 91" <small>standard model *</small>	7,5 / 24,5 <small>3" / 9 5/8"</small>
WLE18	180 70 7/8"	200 78 3/4" <small>standard model *</small>	200 78 3/4"	231 91" <small>standard model *</small>	9,5 / 22,5 <small>3 3/4" / 8 7/8"</small>
		* 210 on request 82 3/4"		* 241 on request 94 7/8"	

Molteni & C

3—
4

bed taking a single piece slatted base

WLE16
black oak eucalyptus
graphite oak structure
structure

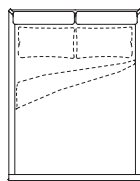
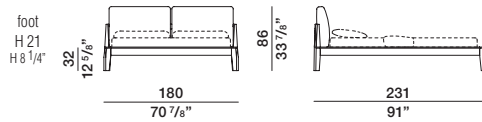

WLE18
black oak eucalyptus
graphite oak structure
structure

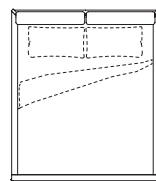
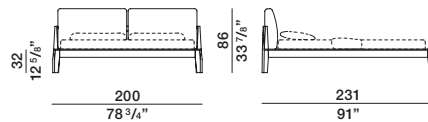

WLE17
black oak eucalyptus
graphite oak structure
structure

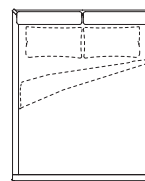
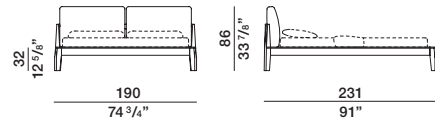

DATASHEET

REGISTERED
DESIGN

IX.2022

DIMENSIONS

beds taking 2 individual single size slatted bases

WLE16T

black oak eucalyptus
graphite oak structure
structure

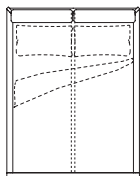
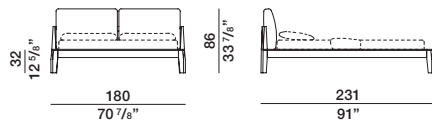

WLE17T

black oak eucalyptus
graphite oak structure
structure

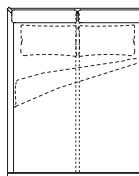
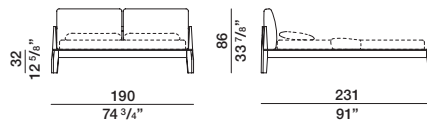

WLE18T

black oak eucalyptus
graphite oak structure
structure

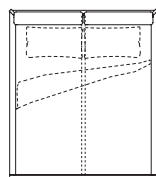
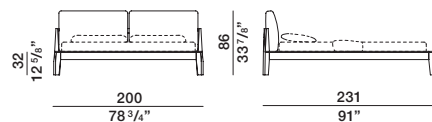

Molteni & C

4—
4

DATASHEET

REGISTERED
DESIGN

IX.2022

moltenigroup.com

Dimensions in centimeters and inches. The right to discontinue and make changes is reserved. This information is based on the latest product information available at the time of printing.