

Molteni & C

FREESTYLE — FERRUCCIO LAVIANI 2006

1—
5



Freestyle is a modular system that exploits the endless combination possibilities of the pieces available to create linear and corner solutions with the greatest freedom in terms of size. The seats can be joined to backs in varying sizes symmetrically or asymmetrically, playing with the cover colours to create combinations in different shades or more traditional single-colour solutions. Freestyle also has two types of arm: a classical piece that flank the structure level with the back or a side cushion that forms one with the seat. As well as the traditional seats there is also a trapezoid end piece, an island element that can further increase the possible composition forms. Freestyle is completed by additional back cushions in three sizes that can be used in the number and fabric type desired. The stitching on the front of the seat and arm lends further elegance to the product.



This symbol shows that the product has removable upholstery. Only qualified personnel can remove the upholstery of some of our products. If this information is pertinent, it will be included in the warnings section.



This symbol shows that the product is available on request in a fire resistant version that complies with the standards BS 5852 and TB 117-2013. The buyer is responsible for checking to make sure that the product is suitable and compliant with the requirements for the designated use and the current applicable laws and standards for the destination and use of the product.

DATASHEET

REGISTERED
DESIGN

IX.2021

TECHNICAL INFORMATION

SEAT

Internal structure is a solid firwood (Picea abies) frame and chipboard, with elastic straps. Padding in variable density high-resistance foam polyurethane. Light velvet cover.

SEAT WITH CUSHIONS

Internal structure is a solid firwood (Picea abies) frame and chipboard, with elastic straps. Padding in variable density high-resistance foam polyurethane. Light velvet cover. Cushion filled with flakes polyurethane and sterilised feathers, 100% cotton cover.

ARM AND BACK

Internal structure is a solid firwood (Picea abies) frame and chipboard, with elastic straps. Padding in variable density high-resistance foam polyurethane. Light velvet cover.

ADDITIONAL CUSHIONS

Cushion filled with flakes polyurethane and sterilised feathers, 100% cotton cover.

FRAME WITH FEET

Painted metal with adjustable feet in non-slip plastic.

REMOVABLE OUTER COVERS

(See attached card, specific for each cover).



AVAILABLE IN FIRE-RESISTANT
VERSION TB117 AND BS5852

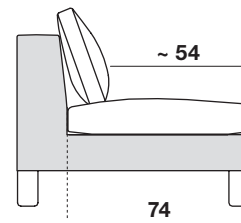
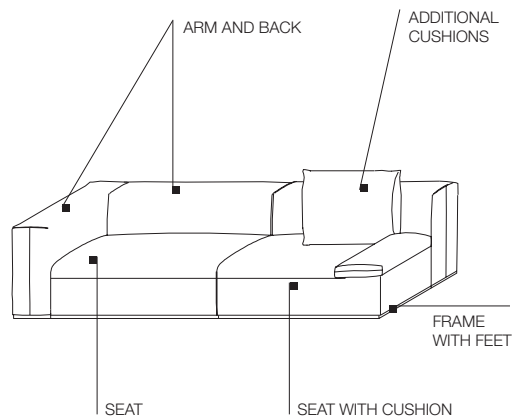

Seat depth for structure only, 74 cm
Seat depth with backrest cushion, ~ 54 cm

DATASHEET

REGISTERED
DESIGN

IX.2021

DIMENSIONS

**Asymmetric
 back example**

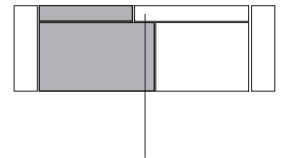
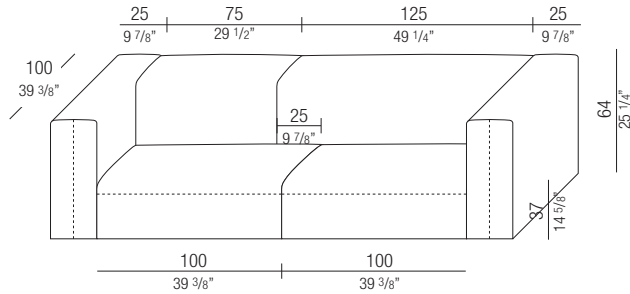

The seat-back alignment can differ by a maximum of 25 cm (9 7/8")

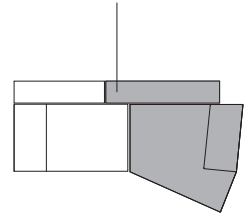

Molteni & C

3—
 5

**Seats with
 cushion arm**

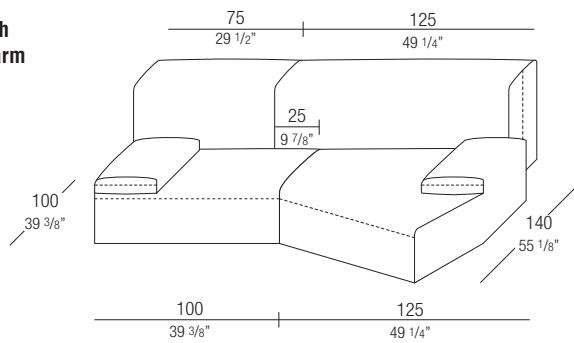

The end piece comes with or without cushion.

An arm can never be used with the end piece.

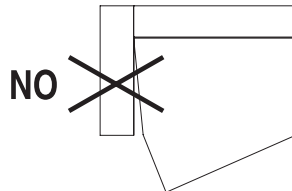

Island element

The elements next to an island must have the seat and the back aligned.

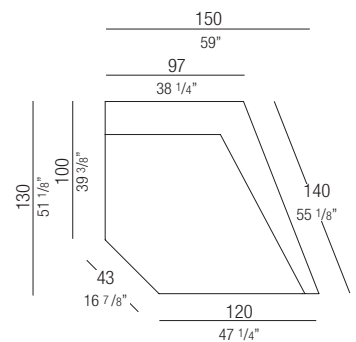
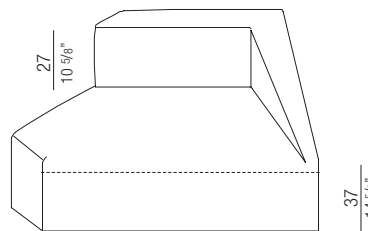

DATASHEET

REGISTERED
 DESIGN

IX.2021

DIMENSIONS

seats

SE12

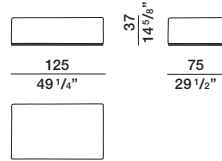

SE10

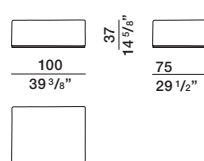

SE75

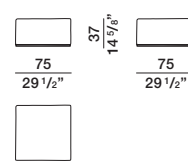

seats with cushion

SC12 dx - sx

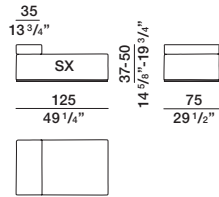

SC10 dx - sx

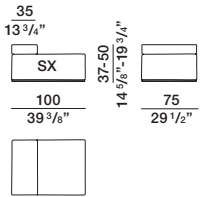

end

TE12 dx - sx

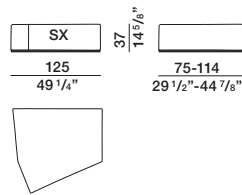

end with cushion

TC12 dx - sx

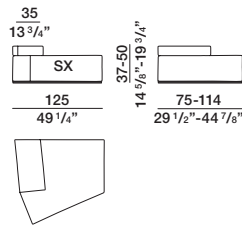

back

SH12

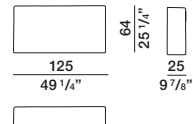

SH10

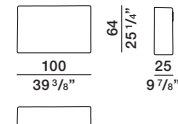

SH75

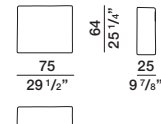

arm

BR10

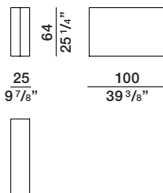

pouf

PF12

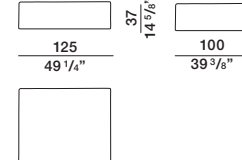

PF10

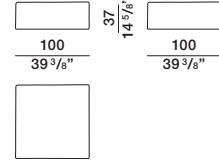

pouf

PF7575

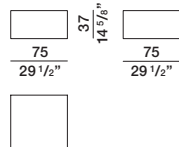

PF1075

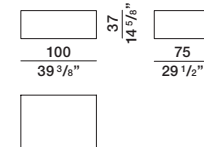

PF1275

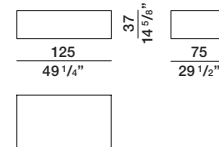

DIMENSIONS

island element

IS15 dx - sx

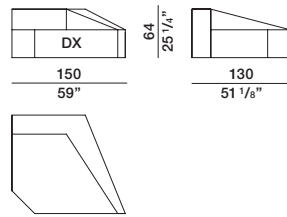

additional cushions

CU/80

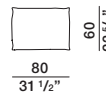

CU/70

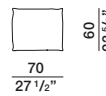

CU/60



Molteni&C

5—
5

SAMPLE COMPOSITIONS

composition 5

L05

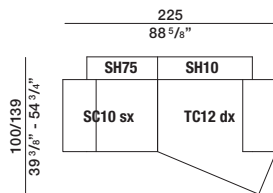

composition 11

A11

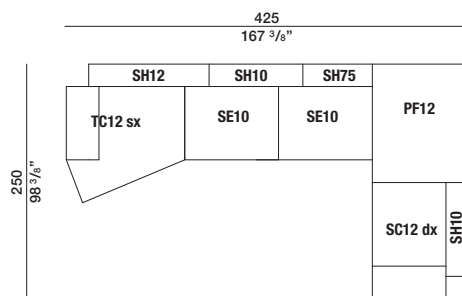

code	gross weight kg.	volume mc.	packages	code	gross weight kg.	volume mc.	packages
BR10	20	0,21	1	SE10	26	0,6	1
IS15	55	1,51	1	SE12	32	0,745	1
PF10	32	0,518	1	SE75	20	0,465	1
PF1075	26	0,6	1	SH10	20	0,21	1
PF12	35	0,637	1	SH12	24	0,26	1
PF1275	32	0,74	1	SH75	16	0,16	1
PF7575	20	0,465	1	TC12	41	1,4	1
SC10	28	0,6	1	TE12	39	1,4	1
SC12	34	0,745	1				

DATASHEET

REGISTERED
DESIGN

IX.2021

Dimensions in centimeters and inches. The right to discontinue and make changes is reserved. This information is based on the latest product information available at the time of printing.