

# Molteni & C

## JULIAN — VINCENT VAN DUYSSEN 2026

1—  
6



The Julian modular system stands out for its imposing presence and generously deep seating, conceived to offer comfort and adaptability to individual preferences through carefully calibrated cushions and lumbar supports. The cushioning is carefully designed to provide a soft, elastic seating experience while maintaining a clean and elegant aesthetic. The padding combines densities and dimensions engineered for balanced ergonomic support, while the distinctive piping unifies the aesthetic. The completeness of the modules - from terminal and central elements to islands and newly designed armrest-coffee tables - opens up endless compositional possibilities, allowing Julian to adapt naturally to any environment, interpreting space with balance and freedom. Julian pairs seamlessly with the Eter coffee table, also by Van Duysen, whose curved version allows for more enveloping and softly rounded compositions.



This symbol shows that the product has removable upholstery. Only qualified personnel can remove the upholstery of some of our products. If this information is pertinent, it will be included in the warnings section.



This symbol shows that the product is available on request in a fire resistant version that complies with the standards BS 5852 and TB 117-2013. The buyer is responsible for checking to make sure that the product is suitable and compliant with the requirements for the designated use and the current applicable laws and standards for the destination and use of the product.

**DATASHEET**

REGISTERED  
DESIGN

2026

**moltenigroup.com**

Dimensions in centimeters and inches. The right to discontinue and make changes is reserved. This information is based on the latest product information available at the time of printing.

## TECHNICAL INFORMATION

### INTERNAL STRUCTURE

Frame made of solid spruce (Picea abies) and particle board panels, with elastic straps.

### STRUCTURE PADDING

High-firmness, polyurethane foam. Cover in bonded velveteen.

### BASE

Painted aluminium with non-slip plastic tips.

### SEAT CUSHIONS

Insert in shaped polyurethane with variable density, cover in 100% cotton.

### BACK CUSHIONS

Insert in polyurethane foam, recycled polyester fibre, 100% cotton cover.

### LUMBAR CUSHIONS

100% cotton cover, polyester fibre.

### TRINKET TRAY

Steel sheet covered in bonded hide leather in colours from the Molteni range.

### STORAGE ARMREST

Medium-density wood fibreboard panel, glossy lacquered.

### CORNER SMALL TABLE WITH GLOSSY LACQUERED STRUCTURE

Glossy lacquered medium-density wood fibreboard.

### CORNER SMALL TABLE WITH GLOSSY TOP

Glossy lacquered medium-density wood fibreboard.

### CORNER SMALL TABLE WITH WOOD TOP

Medium-density wood fibreboard panel covered in oak wood veneer (Quercus).

### REMOVABLE OUTER COVER

(See attached card, specifically for the cover).



AVAILABLE IN FIRE-RESISTANT  
VERSION TB117 AND BS5852

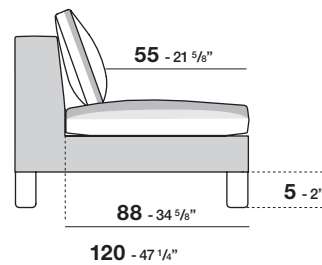
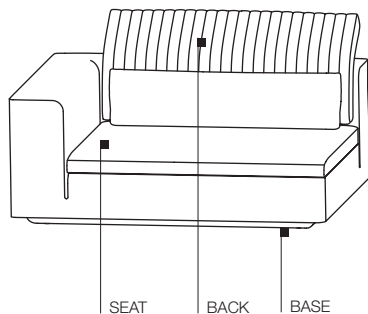

Seat depth for structure only, 88 cm  
Seat depth with backrest cushion 55 cm  
Feet height 5 cm (from ground to under seat)

## NOTES

- ▶ **All modules are supplied with a quilted backrest cushion and a lumbar support cushion. All modules must be covered in the same material and colour.**
- ▶ **The structure and cushions are assembled with a profile according to the following rules:**
  - **fabric covers:**  
**grosgrain profile in the colours indicated in the finishes section.**
  - **leather covers:**  
**profile in the same type of leather and in the colours in the collection.**

## FINISHES

GROSGRAIN FINISHES  
anthracite  
dark brown  
olive green  
paper white  
beaver  
saddle leather colour  
iron  
black  
cream  
sand  
mouse grey

## FINISHES

BONDED HIDE LEATHER  
FINISHES  
ivory  
dark brown  
natural  
mud green  
dove grey  
black  
colonial  
hazelnut

## DATASHEET

REGISTERED  
DESIGN

2026

**DIMENSIONS**

**end element**

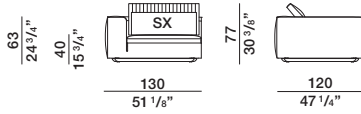

**TE1312 dx-sx**

**end element**

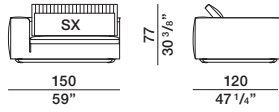

**TE1512 dx-sx**

**end element**

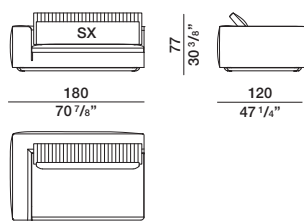

**TE1812 dx-sx**

**end element / corner element**

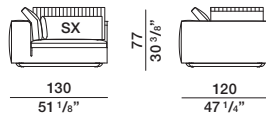

**TA1312 dx-sx**

**end element / corner element**

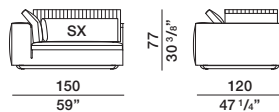

**TA1512 dx-sx**

**back cushion**

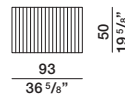

**back cushion**

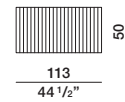

**back cushion**

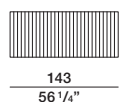

**back cushion A**

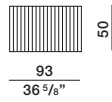

**back cushion B**

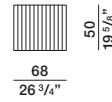

**back cushion A**

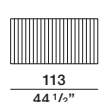

**back cushion B**

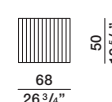

**lumbar cushion**

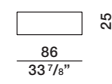

**lumbar cushion**

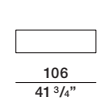

**lumbar cushion**

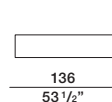

**lumbar cushion C**

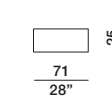

**lumbar cushion C**

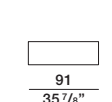

**ornamental back cushion**

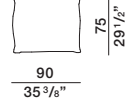

**PCU90/75**

**ornamental back cushion**

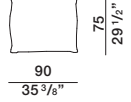

**PCU90/75**

**ornamental back cushion**

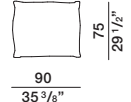

**PCU90/75**

**lumbar cushion D**

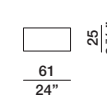

**lumbar cushion D**

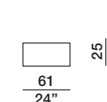

**ornamental back cushion**

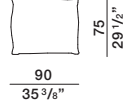

**PCU90/75**

**ornamental back cushion**

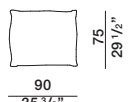

**PCU90/75**

Molteni & C

3  
6

DATASHEET

REGISTERED  
DESIGN

2026

[moltenigroup.com](http://moltenigroup.com)

Dimensions in centimeters and inches. The right to discontinue and make changes is reserved. This information is based on the latest product information available at the time of printing.

**DIMENSIONS**

**end element / corner element**

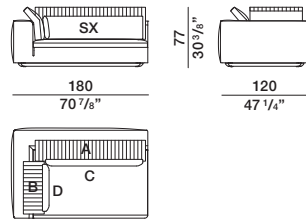

TA1812 dx-sx

**back cushion A**

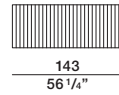

**back cushion B**

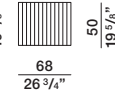

**lumbar cushion C**

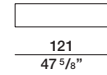

**lumbar cushion D**

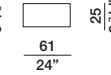

**ornamental back cushion**

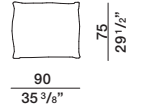

PCU90/75

**central element**

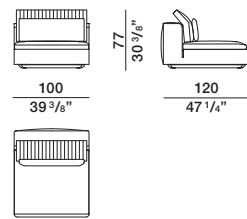

CE1012

**back cushion**

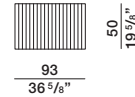

**lumbar cushion**

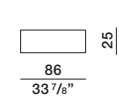

**ornamental back cushion**

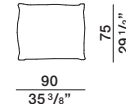

PCU90/75

**central element with storage armrest**

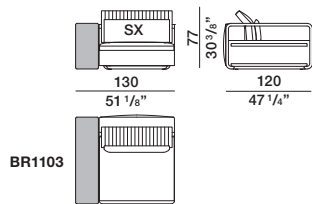

BR1103

CB1312 dx-sx

**back cushion**

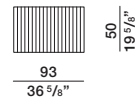

**lumbar cushion**

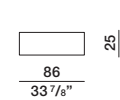

**ornamental back cushion**

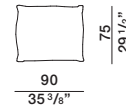

PCU90/75

**central element**

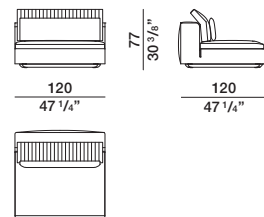

CE1212

**back cushion**

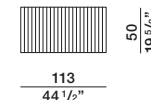

**lumbar cushion**

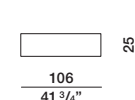

**ornamental back cushion**

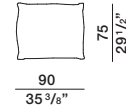

PCU90/75

**central element with storage armrest**

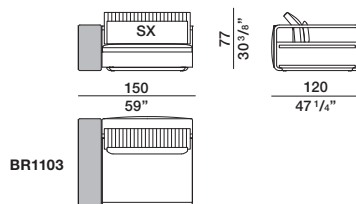

BR1103

CB1512 dx-sx

**back cushion**

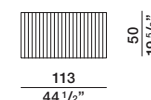

**lumbar cushion**

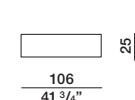

**ornamental back cushion**

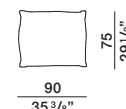

PCU90/75

**DATASHEET**

REGISTERED  
DESIGN

2026

**DIMENSIONS**

**central element**

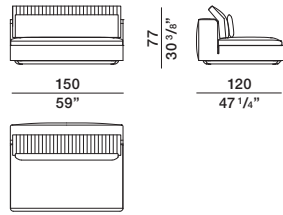

**CE1512**

**central element with storage armrest**

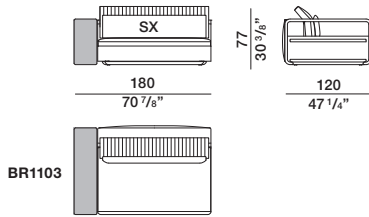

**BR1103**  
**CB1812 dx-sx**

**chaise longue**

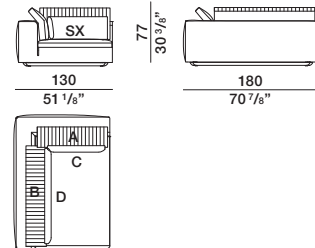

**CL1318 dx-sx**

**chaise longue**

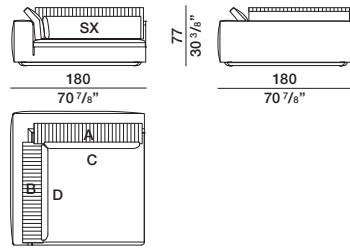

**CL1818 dx-sx**

**daybed**

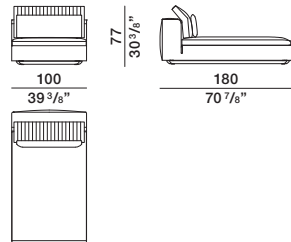

**DA1018**

**back cushion**

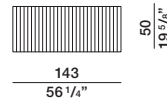

**lumbar cushion**

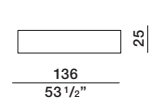

**ornamental back cushion**

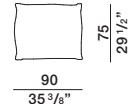

**PCU90/75**

**back cushion**

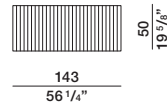

**lumbar cushion**

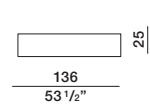

**ornamental back cushion**

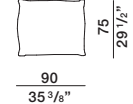

**PCU90/75**

**back cushion A**

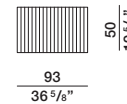

**back cushion B**

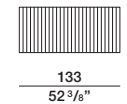

**lumbar cushion C**

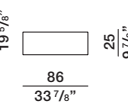

**lumbar cushion D**

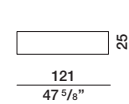

**ornamental back cushion**

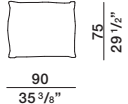

**PCU90/75**

**back cushion A**

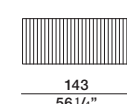

**back cushion B**



**lumbar cushion C**

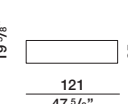

**lumbar cushion D**

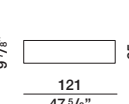

**ornamental back cushion**

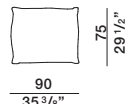

**PCU90/75**

**back cushion**

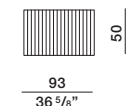

**lumbar cushion**

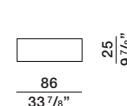

**ornamental back cushion**

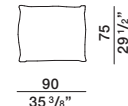

**PCU90/75**

**DATASHEET**

REGISTERED  
DESIGN

2026

**DIMENSIONS**

**daybed with storage armrest**

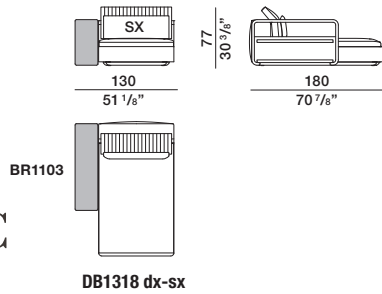

**back cushion**



**lumbar cushion**

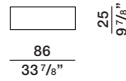

**ornamental  
back cushion**

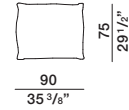

PCU90/75

**pouf**

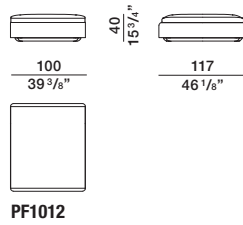

**trinket tray**

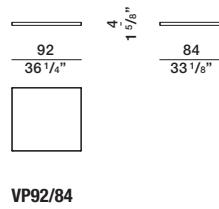

**storage armrest**

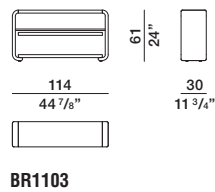

**corner small table**

