

Molteni & C

LARGE — FERRUCCIO LAVIANI 2012

1—
8



Top level technology for the structural elements to guarantee maximum comfort. Comfort which comes of the new generation heat sensitive foam which models itself and distributes weight with optimum efficiency.

FEATURES

Sofa system, with preset composition or modular, marked by well-balanced volumes and generous sizes, and a new concept for the single seat cushion (down + ecomemory) for improved sitting comfort, easier maintenance and better look. The customer can choose the quantity and size of the back cushions.

DATASHEET

REGISTERED
DESIGN

IX.2018

FINISHES

COVERS

fabric - leather, completely removable.

FEET FINISHES

shiny chrome - black chrome - pewter colour

Available in fire-resistant version (TB117 and BS5852).

Molteni & C

2—
8

TECHNICAL INFORMATION

STRUCTURE INTERIOR

Frame made of solid fir (*Picea abies*) and chipboard, with elastic straps.

STRUCTURE PADDING

High capacity variable density foam polyurethane. Light velvet cover.

SEAT CUSHIONS

Insert in shaped polyurethane and sterilised feathers. 100% cotton cover.

BACK CUSHIONS

Down and polyester-filled compartments. 100% cotton cover.

FEET

Bent and laser cut steel, chrome plated or lacquered, with non slip plastic floor rests.

REMOVABLE OUTER COVERS

(See attached card, specific for each cover).

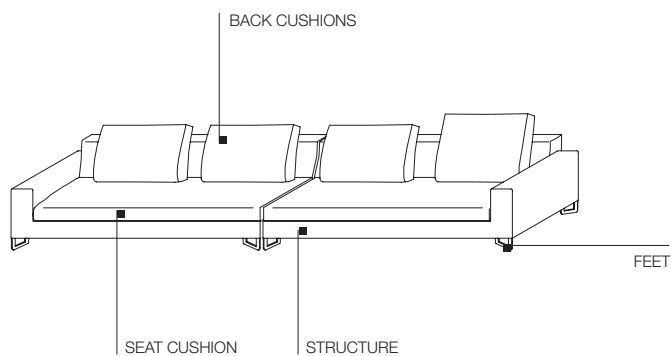

DATASHEET

REGISTERED
DESIGN

IX.2018

DIMENSIONS

Notes

Every single element (sofa, end element, peninsula, corner, island or chaise longue) needs to be completed, for the proper ergonomics, with one or more backrest cushions by choice

Back cushions with variable height

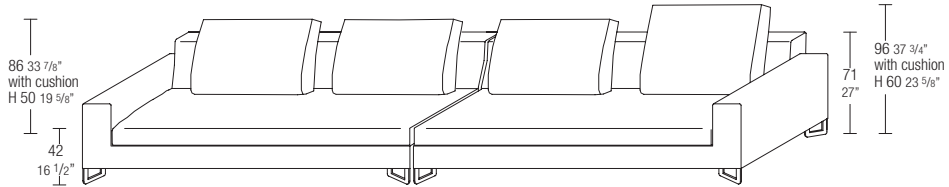

Example for the use of the armrest cushion

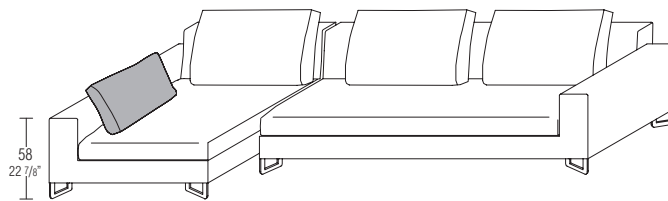

Example with island and pouf

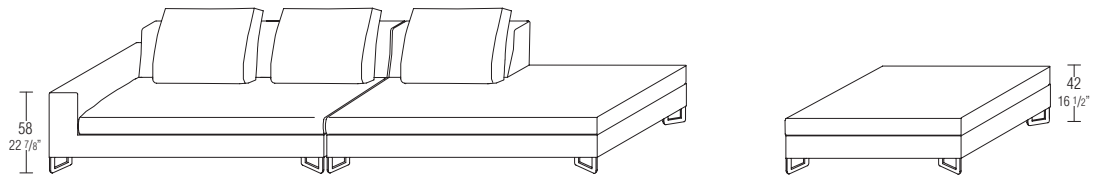

Example for corners

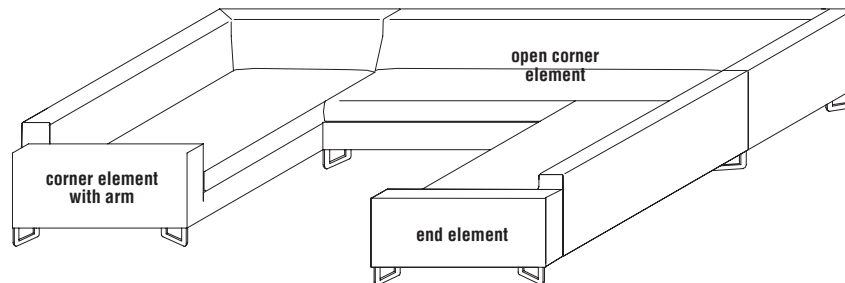

DATASHEET

REGISTERED
DESIGN

IX.2018

DIMENSIONS

Molteni&C

4—
8

sofa structure

DS194

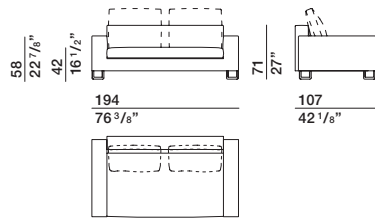

back cushion

CS70/50 - CS70/60

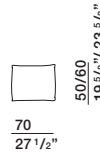

CS75/50 - CS75/60

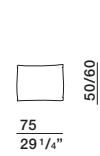

CS90/50 - CS90/60

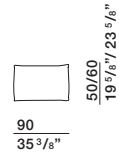

sofa structure

DS224

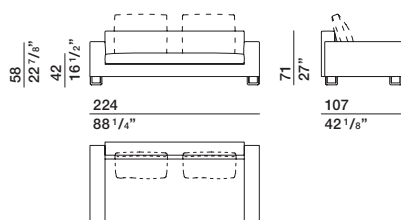

back cushion

CS70/50 - CS70/60

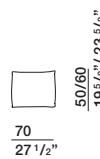

CS75/50 - CS75/60

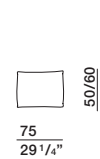

CS90/50 - CS90/60

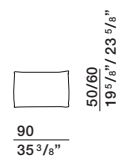

sofa structure

DS254

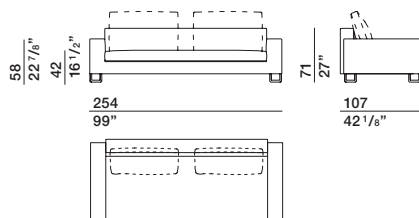

back cushion

CS70/50 - CS70/60

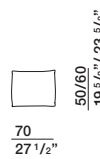

CS75/50 - CS75/60

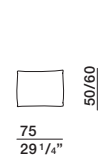

CS90/50 - CS90/60

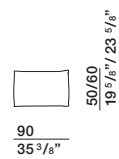

end element structure

TS173 dx - sx

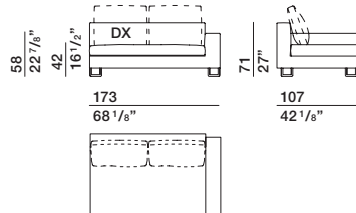

back cushion

CS70/50 - CS70/60

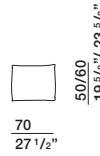

CS75/50 - CS75/60

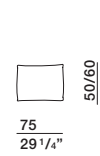

CS90/50 - CS90/60

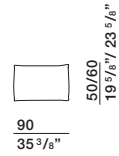

end element structure

TS203 dx-sx

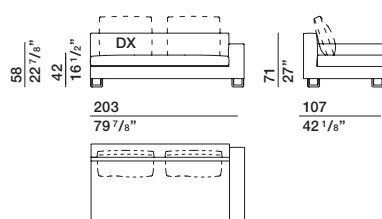

back cushion

CS70/50 - CS70/60

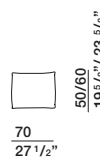

CS75/50 - CS75/60

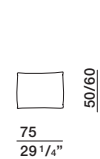

CS90/50 - CS90/60

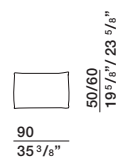

DATASHEET

REGISTERED
DESIGN

IX.2018

DIMENSIONS

Molteni & C

5—
8

end element structure

TS233 dx - sx

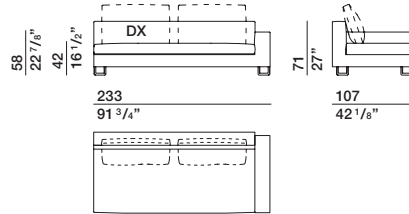

back cushion

CS70/50 - CS70/60

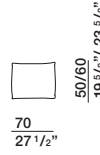

CS75/50 - CS75/60

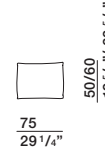

CS90/50 - CS90/60

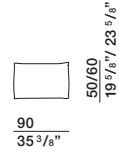

open corner element structure

AAS174 dx - sx

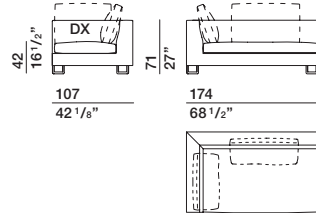

back cushion

CS70/50 - CS70/60

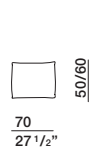

CS75/50 - CS75/60

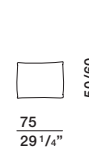

CS90/50 - CS90/60

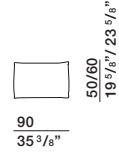

open corner element structure

AAS204 dx - sx

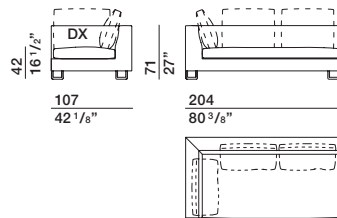

back cushion

CS70/50 - CS70/60

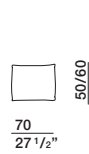

CS75/50 - CS75/60

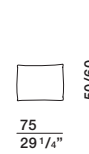

CS90/50 - CS90/60

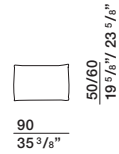

open corner element structure

AAS234 dx - sx

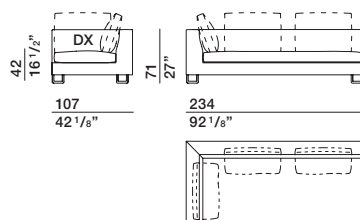

back cushion

CS70/50 - CS70/60

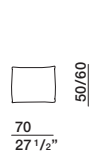

CS75/50 - CS75/60

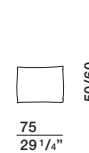

CS90/50 - CS90/60

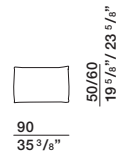

DATASHEET

REGISTERED
DESIGN

IX.2018

DIMENSIONS

Molteni & C

6—
8

corner element with arm structure
ABS195 dx - sx

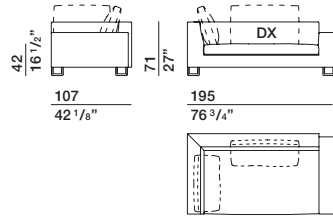

back cushion
CS70/50 - CS70/60

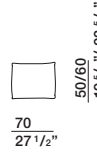

CS75/50 - CS75/60

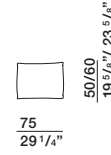

CS90/50 - CS90/60

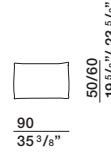

corner element with arm structure
ABS225 dx - sx

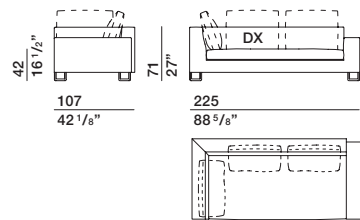

back cushion
CS70/50 - CS70/60

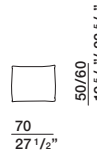

CS75/50 - CS75/60

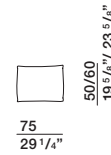

CS90/50 - CS90/60

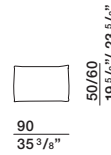

corner element with arm structure
ABS255 dx - sx

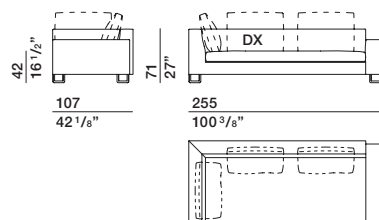

back cushion
CS70/50 - CS70/60

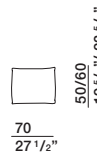

CS75/50 - CS75/60

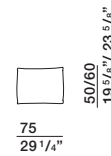

CS90/50 - CS90/60

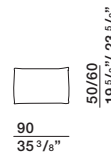

peninsula element structure
PS132 dx - sx

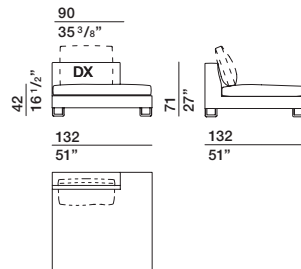

back cushion
CS70/50 - CS70/60

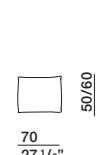

CS75/50 - CS75/60

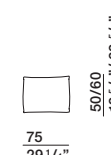

CS90/50 - CS90/60

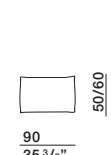

DATASHEET

REGISTERED
DESIGN

IX.2018

DIMENSIONS

Molteni & C

7—
8

island element structure

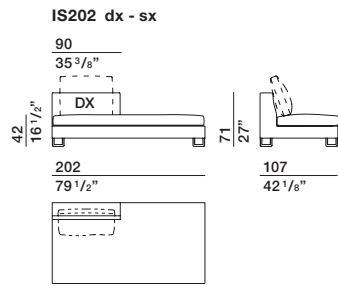

back cushion

CS70/50 - CS70/60

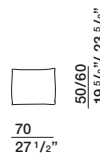

CS75/50 - CS75/60

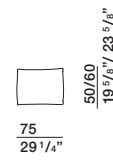

CS90/50 - CS90/60

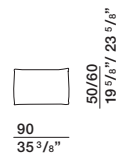

chaise longue structure

CLS162 dx - sx

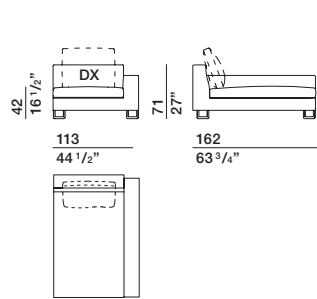

back cushion

CS70/50 - CS70/60

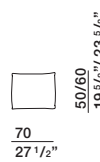

CS75/50 - CS75/60

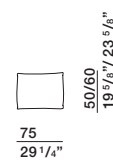

CS90/50 - CS90/60

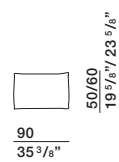

chaise longue structure

CLS202 dx - sx

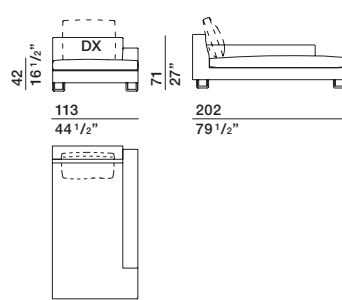

back cushion

CS70/50 - CS70/60

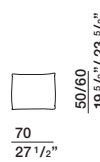

CS75/50 - CS75/60

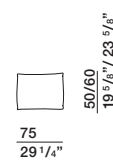

CS90/50 - CS90/60

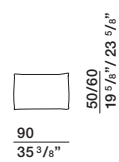

pouf

PF107

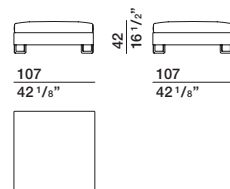

PF122

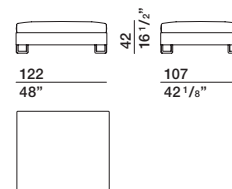

sartorial cushion

LCS/45

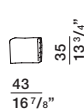

armrest cushion

LBR70/40

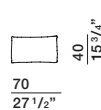

pair of extra cushions

CCQ/50

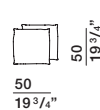

DATASHEET

REGISTERED
DESIGN

IX.2018

SAMPLE COMPOSITIONS

Notes

Specify, besides the code of the complete sofa, the height of the back cushions (H 50 or H 60)

Molteni & C

8—
8

composition 1

end element structure TS203 sx
end element structure TS203 dx
4 cushions CS75/60

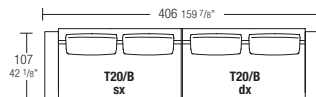

LRC01

composition 2

end element structure TS233 sx
island element structure IS202 dx
3 cushions CS75/60

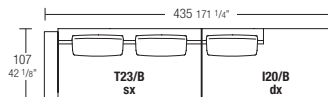

LRC02

composition 3

peninsula element structure PS132 sx
end element structure TS233 dx
3 cushions CS75/60

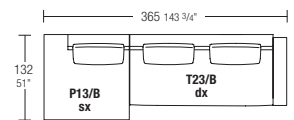

LRC03

composition 4

chaise longue structure CLS162 sx
end element structure TS233 dx
3 cushions CS75/60

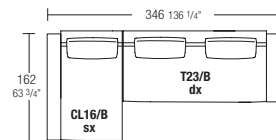

LRC04

composition 5

chaise longue structure CLS202 sx
end element structure TS233 dx
3 cushions CS75/60

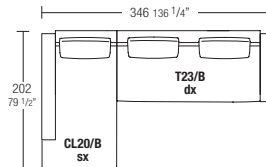

LRC05

composition 7

island element structure IS202 sx
corner element with arm structure ABS255 dx
2 cushions CS70/60
2 cushions CS75/60

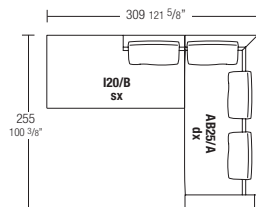

LRC07

composition 8

corner element with arm structure ABS255 sx
end element structure TS203 dx
2 cushions CS70/60
3 cushions CS75/60

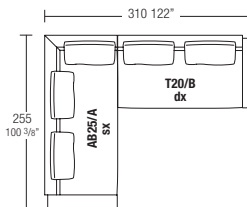

LRC08

composition 9

end element structure TS203 sx
open corner element structure AAS204 dx
pouf PF107
2 cushions CS70/60
3 cushions CS75/60

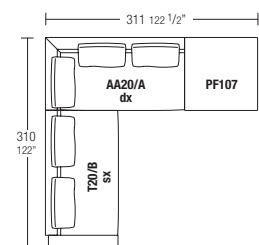

LRC09

composition 10

island element structure IS202 sx
open corner element structure AAS174 dx
end element structure TS173 dx
4 cushions CS70/60
2 cushions CS75/60

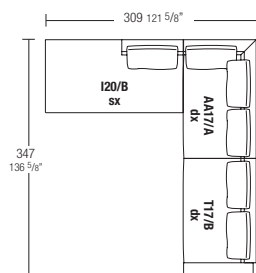

LRC10

DATASHEET

REGISTERED
DESIGN

IX.2018