

Molteni & C

SURF — YABU PUSHELBERG 2019

1—
5



Canadians George Yabu and Glenn Pushelberg, all-round players in the world of architecture, design and graphics since 1980, have just designed Surf, a modular sofa system, for Molteni&C, after making their debut with Dada, in 2006, with the futuristic Lisola design. Thanks to their experience in the hospitality field and in exploring the nature of organic forms well beyond any traditional approach, Yabu Pushelberg design seating, unfettered by the constrictions of excessive modularity and rich in unexpected details. Ideal for residential or hospitality projects, such as hotels or offices. Seats all-one with the base, with rounded forms supporting snug, slightly protruding backrests, are the features that make Surf a design that is not only ergonomically perfect but also visually appealing.

Wallpaper* Design Award, 2020 | Winner, Best Block Party category.



This symbol shows that the product has removable upholstery. Only qualified personnel can remove the upholstery of some of our products. If this information is pertinent, it will be included in the warnings section.



This symbol shows that the product is available on request in a fire resistant version that complies with the standards BS 5852 and TB 117-2013. The buyer is responsible for checking to make sure that the product is suitable and compliant with the requirements for the designated use and the current applicable laws and standards for the destination and use of the product.

DATASHEET

REGISTERED
DESIGN

IX.2021

moltenigroup.com

Dimensions in centimeters and inches. The right to discontinue and make changes is reserved. This information is based on the latest product information available at the time of printing.

FINISHES

SMALL TABLE STRUCTURE FINISH
pewter colour

SMALL TABLE SHELF FINISH
anthracite matt lacquered

SMALL TABLE MARBLE COUNTERWEIGHT FINISH
black marquina

TECHNICAL INFORMATION

INSIDE STRUCTURE

Load-bearing metal frame with elastic bands on the seat.

STRUCTURE PADDING

Cold-moulded polyurethane foam with edging in shaped polyurethane and cotton/polyester fibre cover.

FEET

Plastic.

REMOVABLE OUTER COVER

(See enclosed sheet, specific for the cover in question).

SMALL TABLE

Structure in painted steel. Shaped particle board shelf painted in matt lacquer. Floor level marble counterweight.

INSIDE ARMCHAIR STRUCTURE

Frame made of solid wood (Picea abies) and Polimex (polyester/polyurethane composite material), upholstered with high-bearing, variable-density polyurethane foam. Seat with elastic straps. Cotton-polyester bonded velveteen lining.



AVAILABLE IN FIRE-RESISTANT
VERSION TB117 AND BS5852

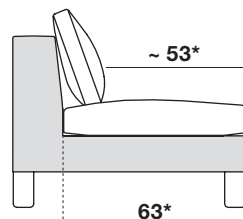
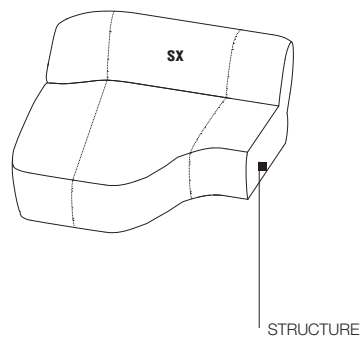

SMALL TABLE

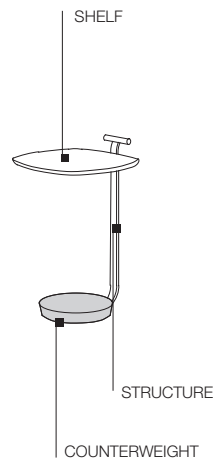

DATASHEET

REGISTERED
DESIGN

IX.2021

Seat depth for structure only, 63 cm (*)

Seat depth with backrest cushion, ~ 53 cm (*)

(*) Central element reference height

DIMENSIONS

armchair
not modular
element

PL09

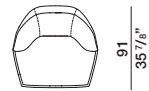
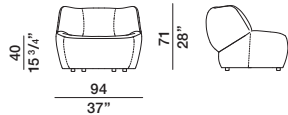

central element
CE10

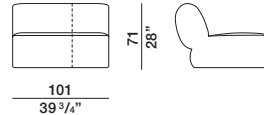

end element
TE15 dx-sx

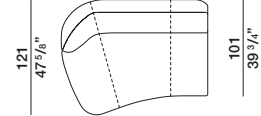
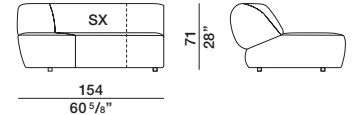

chaise longue

CL14 dx-sx

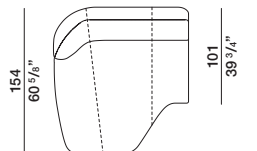
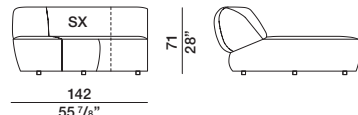

island

IS20 dx-sx

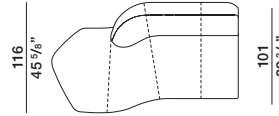
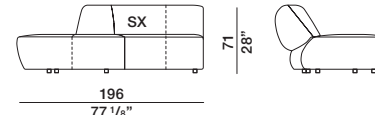

corner element

AN20 dx-sx

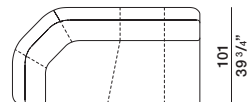
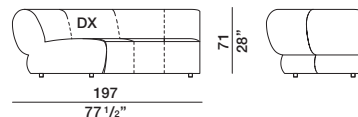

small table

STA1

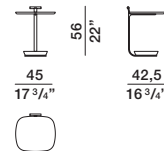

Surf sofas
ornamental cushions

single pair single pair
COS60/40 **COD60/40** **COS60/60** **COD60/60**

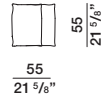

ornamental cushions

single cushion **pair of additional cushions** **additional cushion** **additional cushion** **additional cushion**
CU/50 **CCQ/50** **CU/60** **CU/50/40** **CU40/40**



DATASHEET

REGISTERED
DESIGN

IX.2021

SAMPLE COMPOSITIONS

composition 1

SUC01

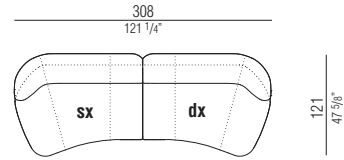

composition 2

SUC02

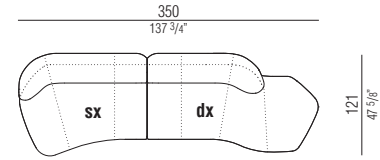

composition 3

SUC03

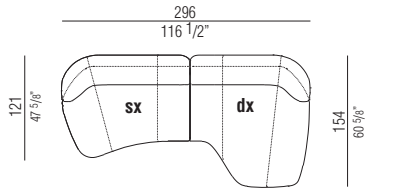

composition 4

SUC04

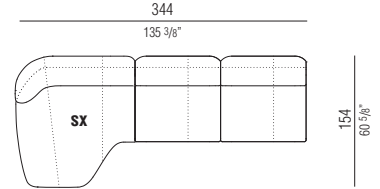

composition 5

SUC05

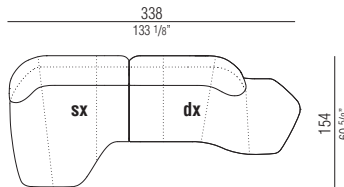

composition 6

SUC06

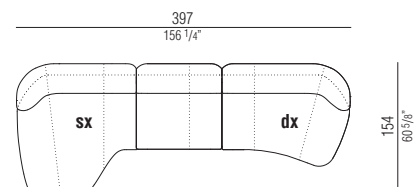

composition 7

SUC07

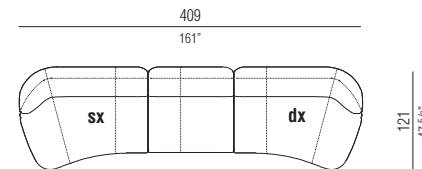

composition 8

SUC08

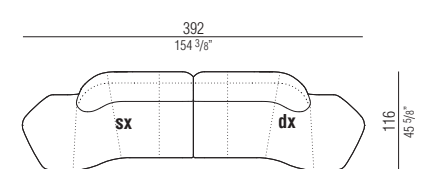

DATASHEET

REGISTERED
DESIGN

IX.2021

SAMPLE COMPOSITIONS

Molteni & C

5—
5

composition 9

SUC09

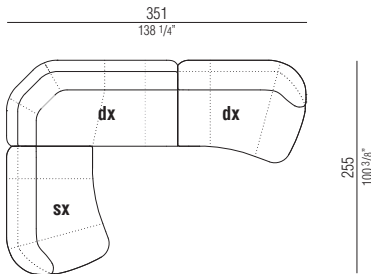

composition 10

SUC10

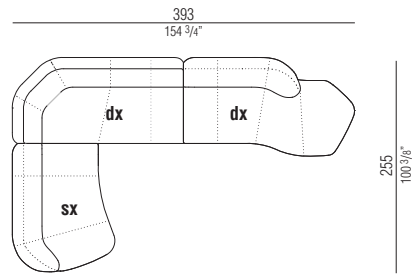

composition 11

SUC11

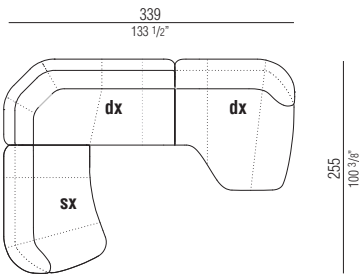

composition 12

SUC12

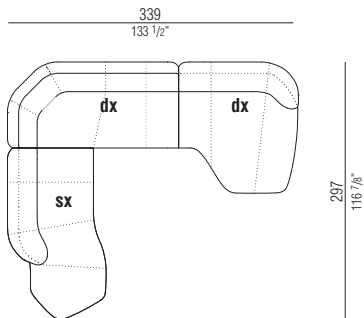

code	gross weight kg.	volume mc.	packages	code	gross weight kg.	volume mc.	packages
CE10	46,5	1	1	IS20	62	1,8	1
TE15	57	1,5	1	AN20	73	1,73	1
CL14	55	1,65	1				

DATASHEET

REGISTERED
DESIGN

IX.2021