

Molteni & C

LISE — CHRISTOPHE DELCOURT 2025

1—
3



The Lise table is characterized by a strong sculptural presence. The harmony of forms is elegantly expressed by the two opposing, curved base structures that intertwine, reaching upwards with grace. Made of rigid polyurethane, the shapes of the base can be finished with a high-gloss lacquered finish or covered with a sheet of polished steel. The top is available in wood with a glossy lacquered, rim or in rich marble with a glossy steel, iridium grey or iridium brown rim. The finish of the rim is consistently mirrored in the base, creating a material continuity between the top and base, giving Lise a distinctive aesthetic.

DATASHEET

REGISTERED
DESIGN

2026

FINISHES

GLOSSY LACQUERED STRUCTURE AND EDGE WITH WOOD TOP

Glossy lacquered colours	Woods
forest green	coffee oak
dark blue gray	black oak
oz yellow	sunrise oak
burgundy red	amber oak
pewter colour	
cappuccino	
sand	

STRUCTURE AND STEEL FRAME WITH STONE OR WOOD INSERT

Marbles (Cat. M1)	Marble (Cat. M7)	Woods
white carrara	breccia capraia	coffee oak
black marquina		black oak
silver wave	Quartzite	sunrise oak
green alpine	avocadus green	amber oak
rain forest green		

Marbles (Cat. M5)	Structure and frame finishes
red lepanto	shiny steel
calacatta	iridium grey
maldive white	iridium brown

TECHNICAL INFORMATION

GLOSSY LACQUERED STRUCTURE AND EDGE WITH WOOD TOP VERSION

LEGS

Rigid polyurethane from mould painted with glossy lacquer with metal insert.

TOP SUPPORT

Painted steel sheet. Only for W 350 steel tubulars.

TOP

Medium-density fibreboard panel covered with oak veneer (Quercus). Glossy lacquered edge.

ADJUSTABLE FEET

Metal with non-slip plastic tips.

STRUCTURE AND STEEL FRAME WITH STONE OR WOOD INSERT VERSION

LEGS

Rigid polyurethane from mould with metal insert painted on the inside part and covered with stainless steel sheets.

TOP SUPPORT

Painted steel sheet. Only for W 350 steel tubulars.

UNDERTOP

Black melamine medium density fibreboard panel.

INSERT

Stone or marble with water-repellent stain-resistant treatment or medium-density fibreboard panel covered with Oak wood veneer (Quercus).

FRAME

Stainless steel.

ADJUSTABLE FEET

Metal with non-slip plastic tips.

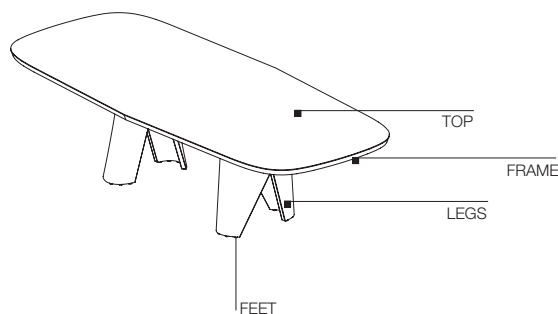

DATASHEET

REGISTERED
DESIGN

2026

DIMENSIONS

glossy lacquered structure and edge with wood top tables

LT25/11

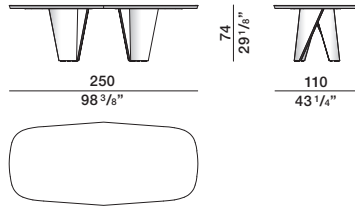

LT29/12

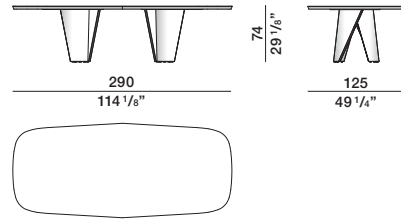

glossy lacquered structure and edge with wood top tables

LT35/12

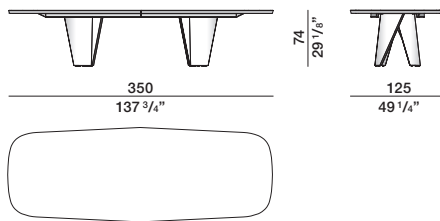

structure and shiny steel frame with stone or wood insert

LT25/11

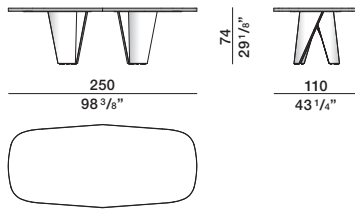

LT29/12

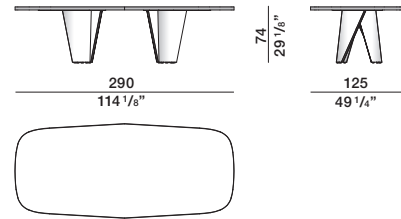

structure and shiny steel frame with stone or wood insert

LT35/12

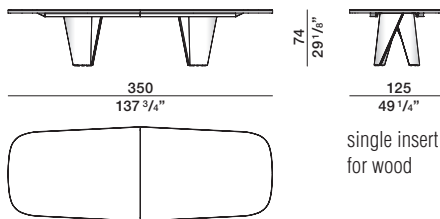

single insert
for wood