

Molteni & C

HUBERT — VINCENT VAN DUYSSEN 2019

1—
2



Set of small tables specifically designed by Vincent Van Duysen to go with the Gregor sofa. They echo the rounded angles of the sofa to create a harmonious whole. Square or rectangular, these are occasional tables each with two wooden horizontal tops, supported by curved hide leather-covered vertical elements, which form a partially closed compartment between the top and the shelf below, designed to hold various handy objects for those sitting on the sofa.

DATASHEET

REGISTERED
DESIGN

IX.2020

FINISHES

WOODEN TOP FINISHES

eucalyptus
walnut

BONDED HIDE LEATHER FINISHES

ivory
dark brown
natural
mud green
dove grey
black

TECHNICAL INFORMATION

TOPS

Chipboard panel, shaped and covered with wood veneer in eucalyptus (*Eucalyptus Globulus*) or walnut (*Juglans Nigra*). The lower shelf sets on the floor on adjustable plastic feet.

CORNER SUPPORTS

Inserts in curved metal sheet covered in bonded hide leather.

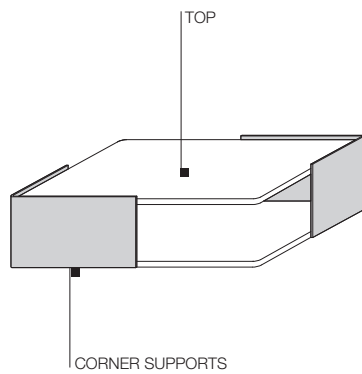

DIMENSIONS

rectangular small tables

HTA1

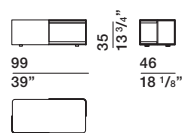

HTA2

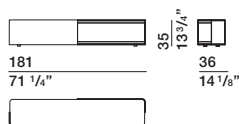

HTA3

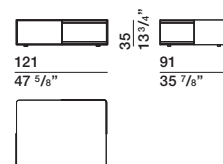

square small tables

HTA4

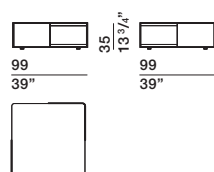

HTA5

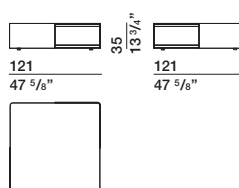

HTA6

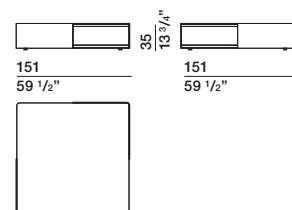

DATASHEET

REGISTERED
DESIGN

IX.2020