

# Molteni & C

## LIVING BOX — VINCENT VAN DUYSSEN 2022

1—  
8



Living Box was conceived as an independent item of furniture, usable in any room of the house, but mainly suitable for the living room. Living Box is a low, but large (230, 280, 330, 380) doorless rectangular container, in which the outside and inside contrast with each other via the use of different materials. The top features marble and different woods, specially arranged to decorate the surface. The whole is enclosed within an iris and pewter frame, thread-like if seen from above, but forming a thick profile surrounding the inside space if seen from the front. The top can be fitted and integrated with trunking, useful for facilitating connections of any kind between multimedia equipment, TVs or lighting equipment. The rest of the top can be left free or used to display artistic or personal ornaments.

The woods used, including Eucalyptus and the new Sunrise Oak finish, are the facing materials used, and which completely envelop and mark the perimeter. Sunrise Oak is like the revisitation of a classic theme reinterpreted with a contemporary taste, without excluding accents of warmth and tactile softness. The new finish, featuring a very light shade skillfully achieved by our expert cabinet makers, is further enhanced by the particular way in which the wood is irregularly brushed according to a time-honoured process reinvented in a modern key.

Suffused lighting is provided by Leds. The inside space is completely free and devoid of sharp corners thanks to special curved corner-covers. The space created in this way allows any type of object to be displayed at will. If this scenographic solution does not fit the purpose, one or more sober and elegant sets of drawers can be added, with an iris and pewter, or a wood finish and featuring a sober and elegant design. These occupy the free space, concealing what is useful but preferably not visible. The sets of drawers are self-standing and can be placed in any part of the room, giving rise to multiple configurations: small architectural items within a larger shell.

The system is completed with a technical Tape container designed to meet the specific requirements linked to the world of video - HIFI equipment.

### DATASHEET

REGISTERED  
DESIGN

IX.2022

## FINISHES

finishes	pewter colour/ iris	wood	marble	painted pewter colour/iris
<b>components</b>				
box - structure (sides, base and internal back)		■		
box - top frame	■			
box - top upper insert		■	■	
drawer / TAPE module		■		■

**Wood**  
EU eucalyptus  
RS sunrise oak

**Marble**  
Sahara noir  
emperador dark  
breccia capraia

# Molteni & C

2—  
8

## TECHNICAL INFORMATION

### BOX STRUCTURE

Adjustable, floor-standing supportive frame in painted tubular metal, to which are fixed parts made of chipboard panel coated with an Oak or Eucalyptus wood veneer (sides, back and base).

### TOP

Frame in painted, extruded and die-cast aluminium, assembled with a chipboard undertop with melamine facing. Upper insert in marble or chipboard panel coated with an Oak or Eucalyptus wood veneer.

### DRAWER MODULE / TAPE MODULE

In chipboard panel with melamine facing painted in the colour range or coated with an Oak or Eucalyptus veneer.

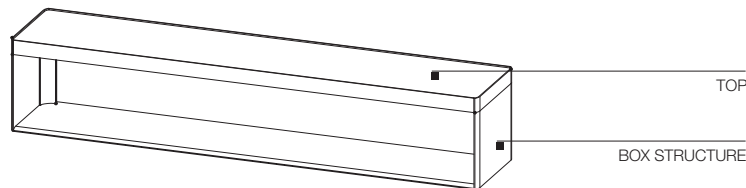

DRAWER MODULE

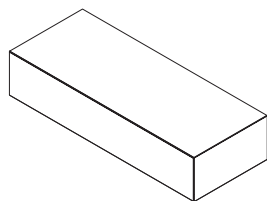

TAPE MODULE

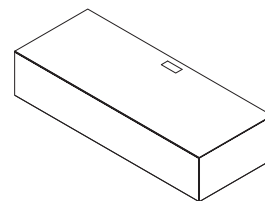

## DATASHEET

REGISTERED  
DESIGN

IX.2022

## MODULARITY

- ▶ With Living box, customers can create multiple compositions by exploiting the space in the most useful way possible.
- ▶ The inside width of the box is 4,4 cm less than the finished size.
- ▶ The modules can never be placed alongside the internal side as the rear of the box features a curved element, connecting the side and the back, in which the vertical LED is inserted.
- ▶ The minimum technical distance from the side for positioning the modules is 8,3 cm but, to make the most of the internal lighting, it is advisable to follow the spacing in the diagrams below.
- ▶ All modules can be a drawer or TAPE. In the event of using a TAPE module, if you require a wire passage on the internal back, please specify the position of the TAPE module as shown in the examples.

# Molteni & C

3—  
8

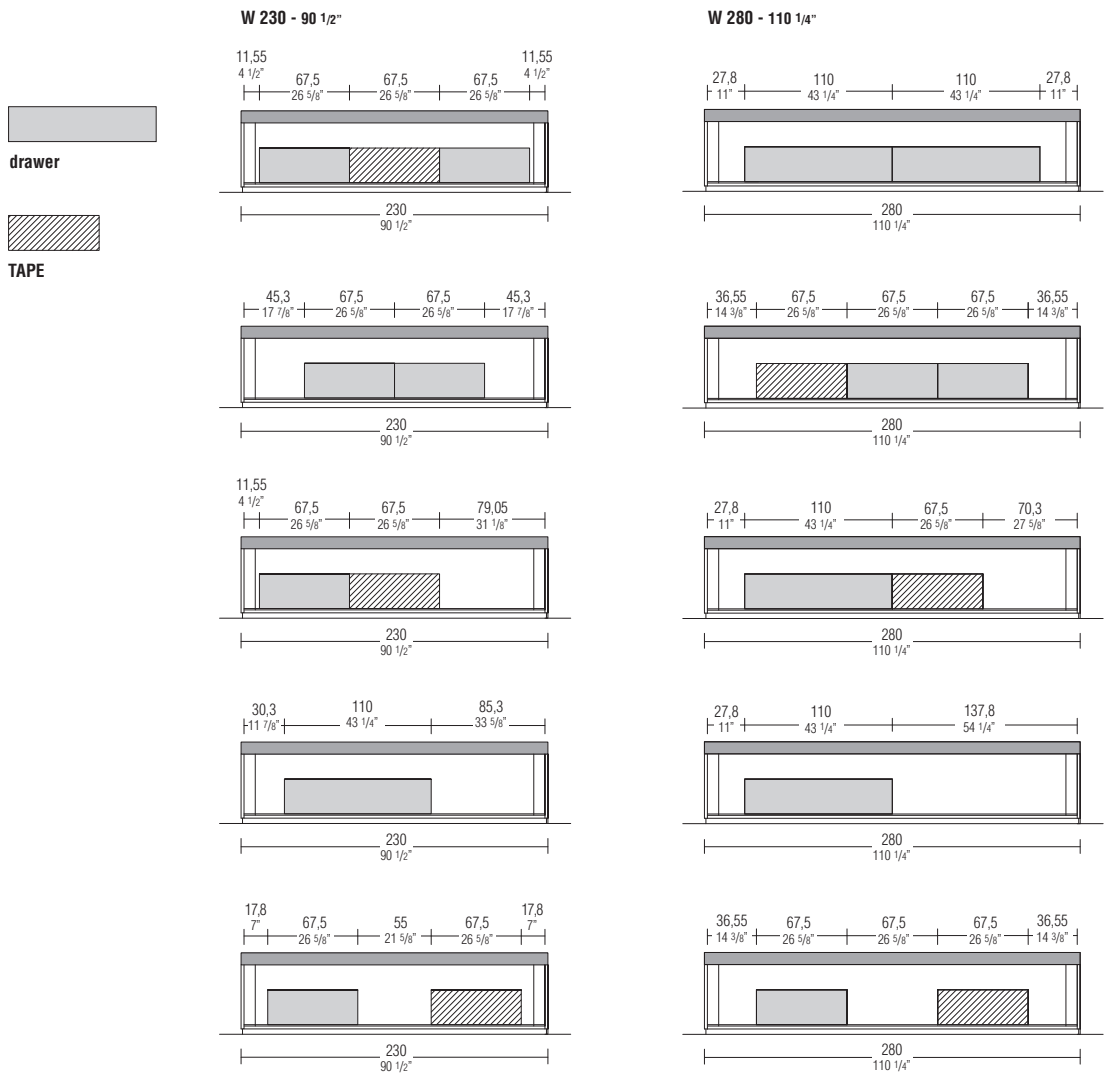
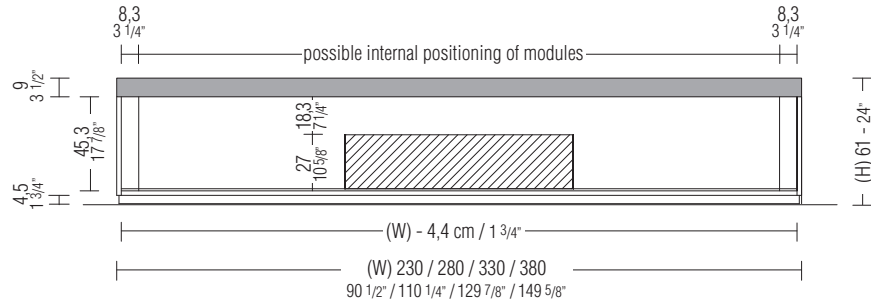

## DATASHEET

REGISTERED  
DESIGN

IX.2022

MODULARITY

Molteni & C

4—  
8

W 330 - 129 7/8"

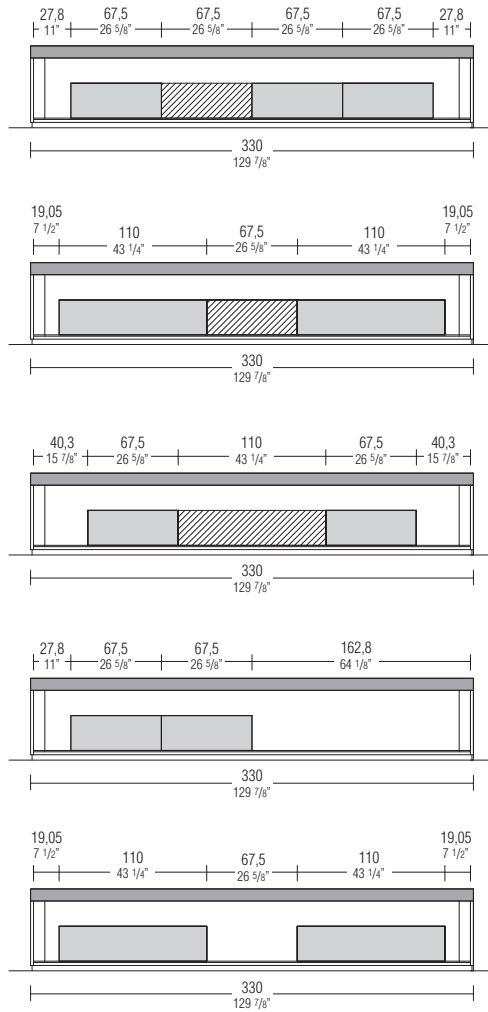

W 380 - 149 5/8"

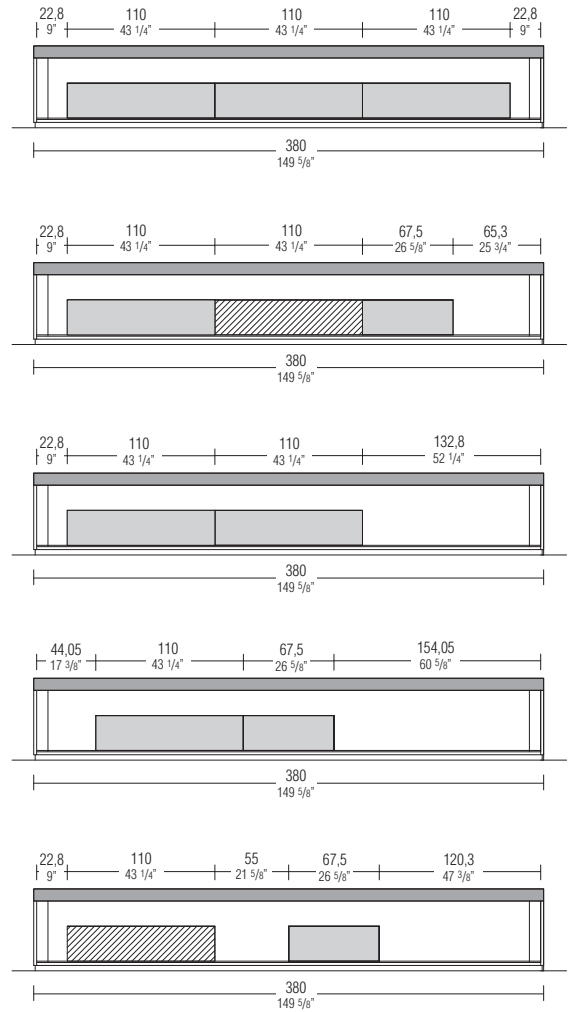

DATASHEET

REGISTERED  
DESIGN

IX.2022

## FEATURES

The rear of Living box comes with a cavity for the passage of wires and electrical connections. This compartment is closed by a removable back which, in the centre of room version, hides wires and cables, allowing them to exit onto the floor (see "Centre of room section").

As for the wall-mounted version, the removable back (which is not visible) can be prepared during installation to adapt to specific situations. It comes as standard with wire passages to access the cavity.

### Example of lighting wire passage

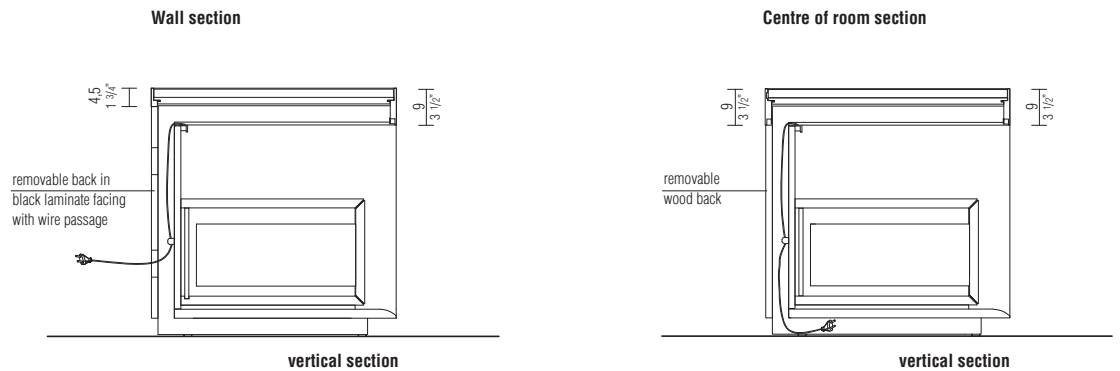

### Top upper insert

The upper insert of the top (in wood and marble) is divided into two parts with a central joint in the W 330 and W 380 versions of the boxes, while in the W 230 and W 280 versions it comes in a single piece. The wood insert is always joined by inlay as per the drawing below.

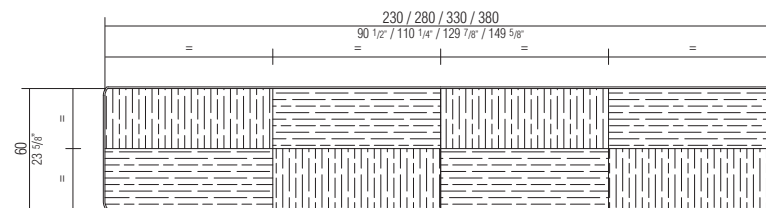

### LED lighting

In both the wall-mounted and centre of room versions, the box can be equipped internally with LED lighting. The lighting system always includes a front LED and a rear LED along the entire length of the box, plus two rear vertical LEDs inserted in the curved profiles. The system can be managed with a controlled socket or with a remote control kit with dimmer (optional).

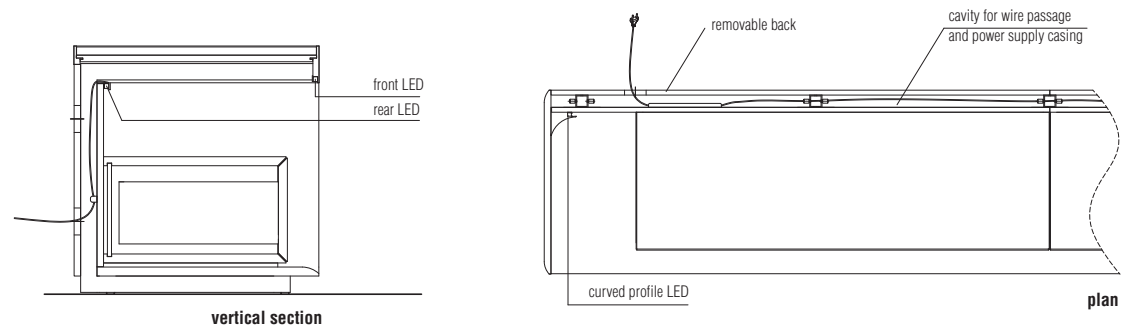

## DATASHEET

REGISTERED  
DESIGN

IX.2022

**FEATURES**

With Living box, the customer can create hi-fi solutions (TV + TV accessories) using the TAPE module and relating wire passages. Below are a few example.

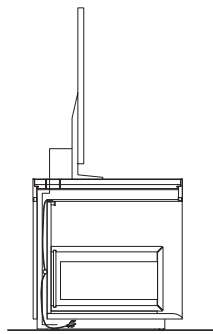
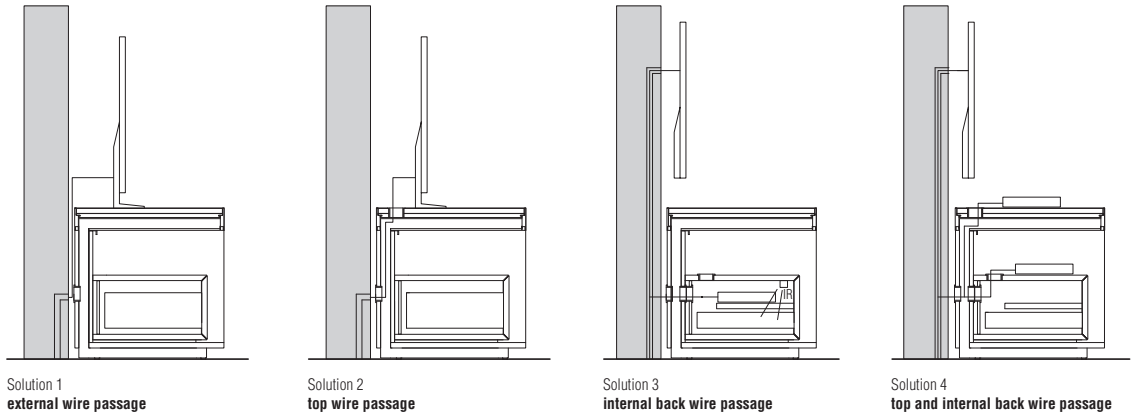

If used in the centre of the room, the wires will exit beneath the base

**Top wire passage**

The Living box top may be accessorised with a rectangular wire passage in the same finish as the upper insert. When ordering, please specify the position of the wire passage. The position of the wire passages cannot be changed not to interfere with the metal structure of the box.

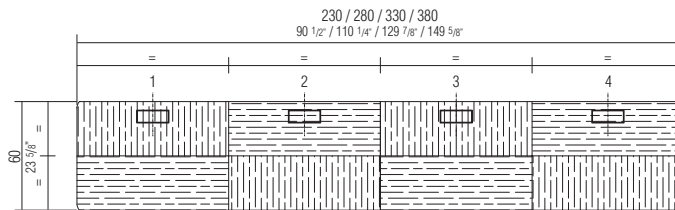

**Internal back wire passage**

The back of the Living box may be accessorised with a rectangular wire passage in the same finish as the back for communication with the TAPE module. When ordering, please specify the position of the TAPE module so as to place the wire passage accordingly (see composition diagrams on page 3/4). Otherwise, the wire passage may be made by the customer.

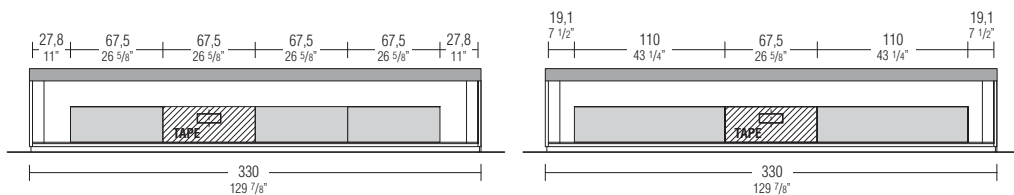

**DATASHEET**

REGISTERED  
DESIGN

IX.2022

**DIMENSIONS**

- ▶ No reductions of any kind are possible.
- ▶ The upper insert of the top (in wood and marble) is divided into two parts with a central joint in the W 330 and W 380 versions of the boxes, while in the W 230 and W 280 versions it comes in a single piece.
- ▶ When ordering, please specify:
  - box wood
  - top insert finish
  - top frame finish

**Box**

**D 61 - 24"**  
**H 61 - 24"**

**W 230 - 90 1/2"**



wall mounted **BP23/06**    centre of room **BC23/06**

**W 280 - 110 1/4"**



wall mounted **BP28/06**    centre of room **BC28/06**

**Box**

**D 61 - 24"**  
**H 61 - 24"**

**W 330 - 129 7/8"**

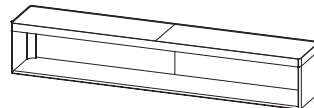

wall mounted **BP33/06**    centre of room **BC33/06**

**W 380 - 149 5/8"**

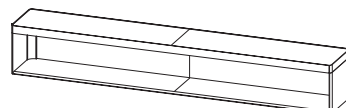

wall mounted **BP38/06**    centre of room **BC38/06**

**Rectangular wire passages**

When ordering, please specify the position

**Top**



**EPA6**

**Internal back panel**



**EPA7**

**LED lighting**

For controlled socket

**W 230 - 90 1/2"**

**W 280 - 110 1/4"**

**W 330 - 129 7/8"**

**W 380 - 149 5/8"**

**Remote control kit with dimmer (optional)**



**EIL23/06**

**EIL28/06**

**EIL33/06**

**EIL38/06**



**EKRR1**

**DATASHEET**

REGISTERED  
DESIGN

IX.2022

## DIMENSIONS

- ▶ No reductions of any kind are possible.
- ▶ The drawer and TAPE modules may be positioned freely inside the box, except that the positioning of the TAPE module should be specified if a wire passage is required on the internal back.
- ▶ The TAPE module is always equipped with rear access and upper wire passage.
- ▶ The drawers and TAPE modules are always fully extractable.

### Drawer module

D 46 - 18 1/8"  
H 26 - 10 1/4"

W 67,5 - 26 5/8"

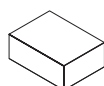

MC06/02

W 110 - 43 1/4"

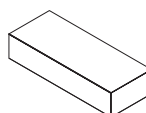

MC11/02

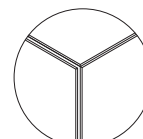

Front detail

### TAPE module

D 46 - 18 1/8"  
H 26 - 10 1/4"

W 67,5 - 26 5/8"

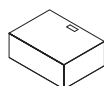

MT06/02

W 110 - 43 1/4"

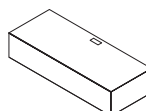

MT11/02

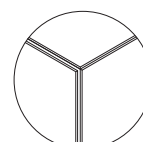

Front detail

TV signal transceiver system  
with LED light (transmission  
frequency from 30 to 38 KHz)

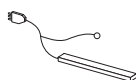

for 1 compartment  
ETV1L

## DATASHEET

REGISTERED  
DESIGN

IX.2022