

# Molteni & C

## ADRIEN — VINCENT VAN DUYSSEN 2018

1—  
6



Adrien expresses a desire to present a new series of storage units, conceptually avant-garde both in technological and in aesthetic terms. Adrien is a fortunate combination of purity of form and exclusive materials and technologies, blended harmoniously and with a focus on key visual and tactile aspects. This new system of storage units develops the concept of rigorous containers defined by absolute transparency. In Adrien the structural aluminium thickness is reduced to a minimum, allowing the Stopsol glass and the built-in LED lighting system of the shelves to enhance the appeal of the objects displayed. A four- or five-door configuration with just one height. The back panel can be made of wood, Fine Grain or glass to highlight the complete transparency of the object. The door, made only of glass, opens thanks to a new patented 95° hinge.

### DATASHEET

REGISTERED  
DESIGN

IX.2020

**NOTES**

- ▶ Cupboard available in three sizes with sides and doors in glass.
- ▶ The back can be made in the same finish as the sides or in fine grain or in wood.
- ▶ The internal parts are always in wood, and the top can be either in marble th 2 cm or wood th 3 cm.
- ▶ The upper top panel is mandatory.
- ▶ The cupboard can be equipped with a lighting system.
- ▶ The LED bars can be inserted on the lid or on the shelves in wood or glass.
- ▶ The cupboard can be used in the centre of the room only in the version with the glass back.

**Molteni & C**

2—  
6

finishes		woods	pewter colour	transparent glass	transparent stopsol glass	fine grain	marble	saffiano melamine
<b>components</b>								
side panel	profile							
	glass							
frame central partition	profile							
	glass							
base and lid								
back panel								
glass back panel	profile							
	glass							
finishing top								
door	profile							
	glass							
shelf								
glass shelf	profile							
	glass							
drawers front								
drawer internal								

**colours**

**Woods**

EU eucalyptus  
RF graphite oak

**Marbles**

emperador dark  
orient grey  
Sahara noir  
calacatta gold

**DATASHEET**

REGISTERED  
DESIGN

IX.2020

## TECHNICAL INFORMATION

### LID, BASE, TOP, FRONTS AND DRAWER STRUCTURE, BACK PANEL AND WOOD TOP

Wood particle board paneling covered with sliced veneer in Eucalyptus (*Eucalyptus globulus*) or Oak (*Quercus*).

### FINE GRAIN BACK PANEL

Chipboard coated with cylinder etched coextruded sheet of ABS-PMMA, painted in specific Molteni finish.

### GLASS DOOR, SIDES, SHELF AND BACK PANEL

Frame in extruded aluminum with crystal, thickness. 4 mm available in different finishes. The doors open via a recessed hinge in the sides.

### FLOOR PROFILE

Extruded anodized aluminum.

### SIDES AND DRAWER BOTTOMS

Wood particle board paneling covered with melamine finish.

### LIGHTING AND ELECTRICAL COMPONENTS

All components are compliant with regulations and certified as shown on the individual parts.

### MARBLE TOP

Marble with finishes from the range.

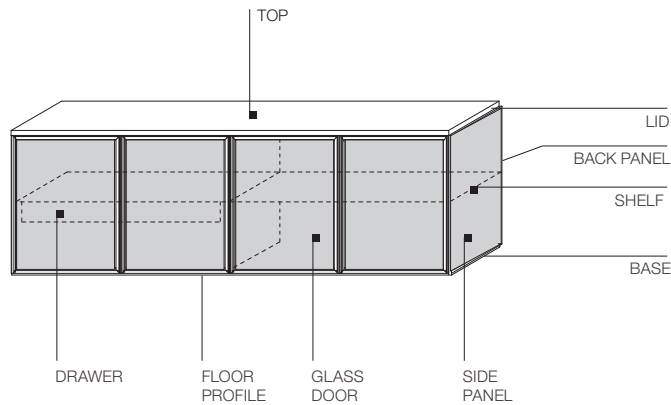

## DATASHEET

REGISTERED  
DESIGN

IX.2020

## DIMENSIONS

Molteni & C

4—  
6

### cupboard

#### without internal shelves

H 88 - 34 5/8" wood top  
H 87 - 34 1/4" marble top  
D 52,7/53,7 - 20 3/4" / 21 1/8"  
with glass back panel

### transparent glasses

wood top	emperor dark/ orient grey top	Sahara noir/ calacatta gold top
<b>MA08/19E</b>	<b>MA08/19M</b>	<b>MA08/19S</b>

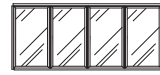

199,8  
78 5/8"

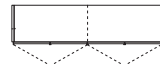

87/88  
34 1/4" / 34 5/8"  
52,7/53,7  
20 3/4" / 21 1/8"

### transparent stopsol glasses

wood top	emperor dark/ orient grey top	Sahara noir/ calacatta gold top
<b>MA08/19E</b>	<b>MA08/19M</b>	<b>MA08/19S</b>

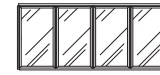

199,8  
78 5/8"

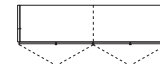

87/88  
34 1/4" / 34 5/8"  
52,7/53,7  
20 3/4" / 21 1/8"

### cupboard

#### without internal shelves

H 88 - 34 5/8" wood top  
H 87 - 34 1/4" marble top  
D 52,7/53,7 - 20 3/4" / 21 1/8"  
with glass back panel

### transparent glasses

wood top	emperor dark/ orient grey top	Sahara noir/ calacatta gold top
<b>MA08/24E</b>	<b>MA08/24M</b>	<b>MA08/24S</b>

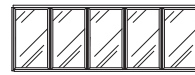

249  
98"

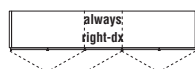

87/88  
34 1/4" / 34 5/8"  
52,7/53,7  
20 3/4" / 21 1/8"

### transparent stopsol glasses

wood top	emperor dark/ orient grey top	Sahara noir/ calacatta gold top
<b>MA08/24E</b>	<b>MA08/24M</b>	<b>MA08/24S</b>

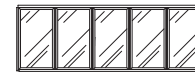

249  
98"

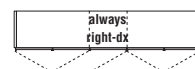

87/88  
34 1/4" / 34 5/8"  
52,7/53,7  
20 3/4" / 21 1/8"

### cupboard

#### without internal shelves

H 88 - 34 5/8" wood top  
H 87 - 34 1/4" marble top  
D 52,7/53,7 - 20 3/4" / 21 1/8"  
with glass back panel

### transparent glasses

wood top	emperor dark/ orient grey top	Sahara noir/ calacatta gold top
<b>MA08/26E</b>	<b>MA08/26M</b>	<b>MA08/26S</b>

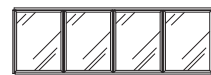

265,4  
104 1/2"

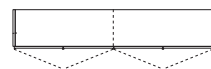

87/88  
34 1/4" / 34 5/8"  
52,7/53,7  
20 3/4" / 21 1/8"

### transparent stopsol glasses

wood top	emperor dark/ orient grey top	Sahara noir/ calacatta gold top
<b>MA08/26E</b>	<b>MA08/26M</b>	<b>MA08/26S</b>

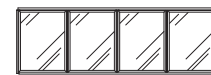

265,4  
104 1/2"

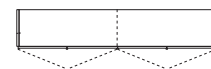

87/88  
34 1/4" / 34 5/8"  
52,7/53,7  
20 3/4" / 21 1/8"

## DATASHEET

REGISTERED  
DESIGN

IX.2020

moltenigroup.com

Dimensions in centimeters and inches. The right to discontinue and make changes is reserved. This information is based on the latest product information available at the time of printing.

## DIMENSIONS

It is possible to insert  
no. 1 shelf  
for compartment

**shelf th 3**  
W 46,2 D 42,8  
W 18 1/4" D 16 7/8"

W 95,4 D 42,8  
W 37 1/2" D 16 7/8"

W 128,2 D 42,8  
W 50 1/2" D 16 7/8"



RI/04

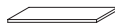

RI/09

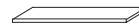

RI/13

# Molteni & C

5 —  
6

To be fastened under  
the lid or the  
wooden shelf

**structure with drawer**  
H 11,8 - 4 5/8"  
module W 46,2 - 18 1/4"

module W 95,4 - 37 1/2"

module W 128,2 - 50 1/2"



SCL04/11



SCL09/11



SCL13/11

### Use of structure with drawer

In the presence of a structure with drawer it is not possible  
to apply the LED bar under the lid or shelf

#### under the lid

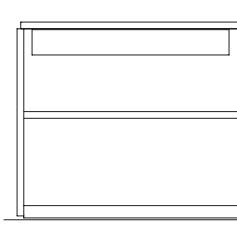

#### under the wooden shelf

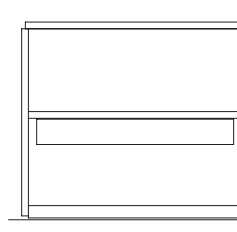

## DATASHEET

REGISTERED  
DESIGN

IX.2020

## DIMENSIONS

### Lighting system

#### Lighting bars with front LEDs

Internal compartments of Adrien can be equipped with front LED lighting bars. The lighting bar can be mounted on the lids or on the shelves in wood or transparent glass, using the electrified wire strip mounted on the left side panel of the compartment. For each compartment size, we have made specific lighting bars with wiring compliant with European safety standards.

#### Notes

When ordering, the client must indicate how many shelves with lighting bars are desired.

**Individual wire strip is always installed on the left side panel of the compartment.**

**The lighting bars cannot be used in the presence of structures with drawer.**

Molteni & C

6—  
6

<b>lighting bars</b> <b>3000 K</b>	W 46,2 - 18 1/4" 4 watt	W 95,4 - 37 1/2" 8 watt	W 128,2 - 50 1/2" 10,5 watt
---------------------------------------	----------------------------	----------------------------	--------------------------------

EBI4C

EBI9C

EBI13C

**components**  
**per system**

**power supply unit**  
**block 100W**  
**with watertight box**  
(positioned under the  
left-side base of each  
composition)

**electrified wire strip**  
to insert into the left side  
panel of compartments with  
lighting bars

**radio control kit**  
**with brightness setting**  
**(1 per power supply unit)**  
**optional**

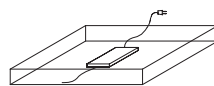

EAB1

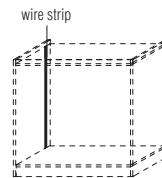

ECA4



EKRR1

## DATASHEET

REGISTERED  
DESIGN

IX.2020