

Molteni & C

HI-BRIDGE — FERRUCCIO LAVIANI 2005

1—
5



Large-size seats for handy and comfortable use. A very versatile system made up of plain, linear shapes. Ferruccio Laviani designs a line of seats for today's homes with the absolute elegance of classic style. The cushions set casually on top overlap the continuous profile of the backrest to create different seat configurations. The seats project from the overall shape of the load bearing structures, protecting the base and emphasizing the comfort of the large seat surfaces. Large end elements to suit a sofa understood as a welcoming shelter to lie down in.

FEATURES

A series of upholstered sofas, individual or modular, characterised by a L shaped double structure when combining 2 sofas together, as the structure of one element is extended in order to be inserted under the sofa next to it.

DATASHEET

IX.2018

moltenigroup.com

Dimensions in centimeters and inches. The right to discontinue and make changes is reserved. This information is based on the latest product information available at the time of printing.

FINISHES

COVERS

fabric - leather, completely removable.

Available in fire-resistant version (TB117 and BS5852).

FEET FINISH

shiny steel

Molteni & C

TECHNICAL INFORMATION

STRUCTURE INTERIOR

Frame made of solid fir (Picea abies) and chipboard, with elastic straps.

STRUCTURE PADDING

High capacity variable density foam polyurethane. Light velvet cover.

SEAT CUSHION (EXCEPT OF POUF)

Insert in shaped polyurethane and sterilised feathers. 100% cotton cover.

BACK CUSHIONS

Shaped polyurethane flakes and sterilized feathers. 100% cotton cover.

FEET (EXCEPT OF POUF)

Shiny metal with non-slip plastic tips.

REMOVABLE OUTER COVERS

(See attached card, specific for each cover).

2—
5

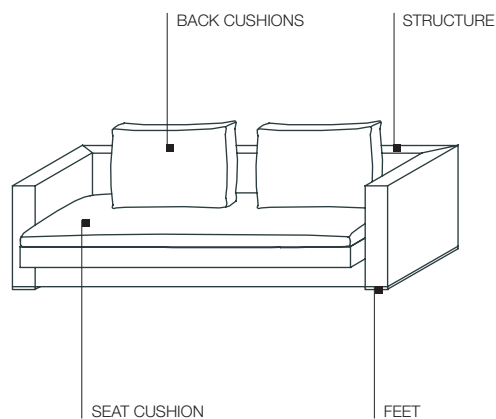

DATASHEET

IX.2018

COMPOSITIONS

Measurement for compositions

Compositions are always created using an end element.
When considering angle depth, use armrest depth 80 cm (31 1/2") and not total depth of the element 97 cm (38 1/4")

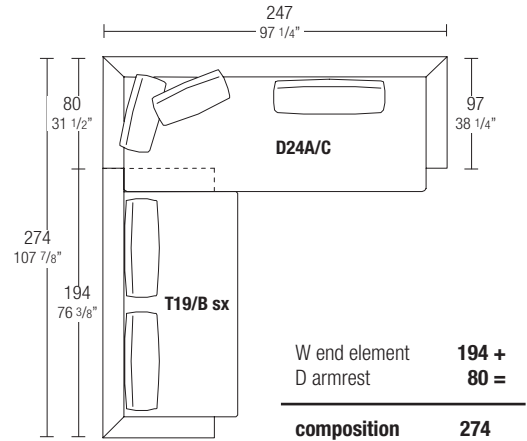

Molteni & C

3—
5

Measurement for a composition with a modular pouf

If a modular pouf is added as end element, it will lengthen the composition of 43 cm (16 7/8").

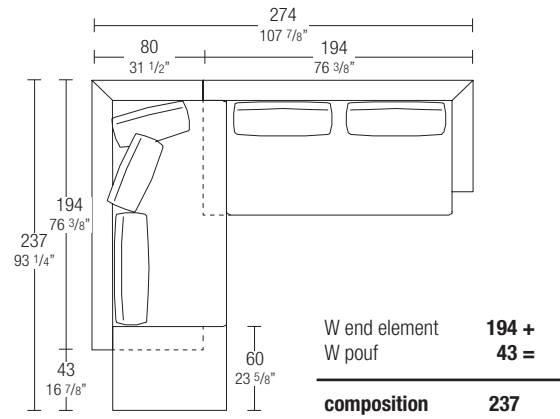

DIMENSIONS

sofa structure

DS194

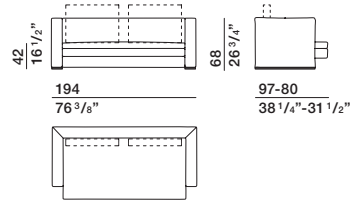

back cushion

CS80

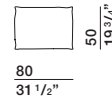

CS70

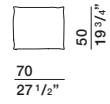

CS55

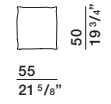

Molteni & C

**sofa structure
single cushion seating**

DS247A

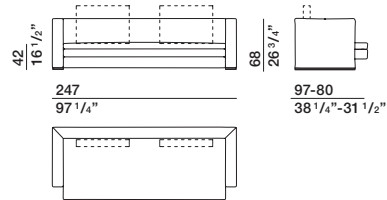

back cushion

CS80

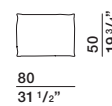

CS70

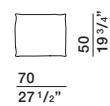

CS55

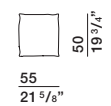

4—
5

**sofa structure
multi cushion seating**

DS247B

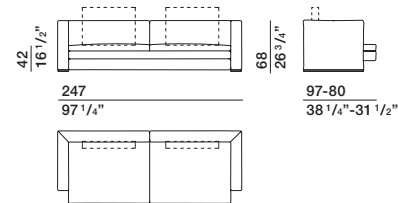

back cushion

CS80

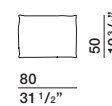

CS70

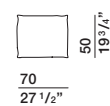

CS55

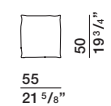

chaise longue structure

CLS177 dx - sx

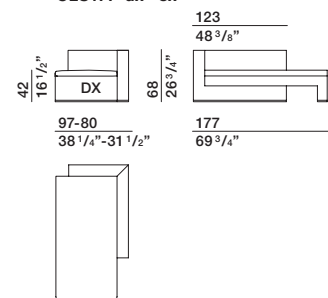

back cushion

CS80

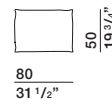

CS70

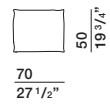

CS55

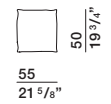

DATASHEET

IX.2018

moltenigroup.com

Dimensions in centimeters and inches. The right to discontinue and make changes is reserved. This information is based on the latest product information available at the time of printing.

DIMENSIONS

chaise longue structure

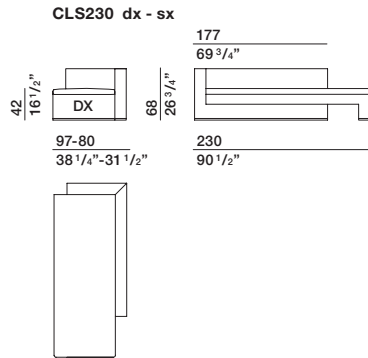

back cushion

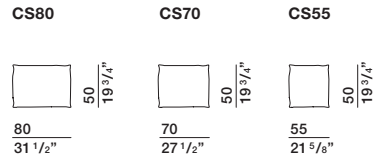

Molteni & C

5—
5

end element structure

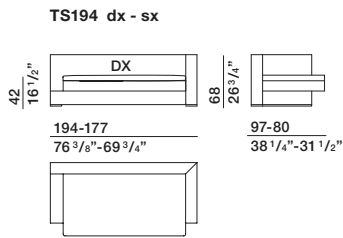

back cushion

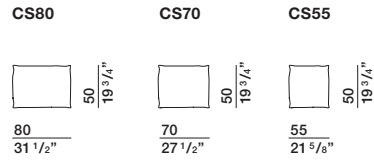

end element structure

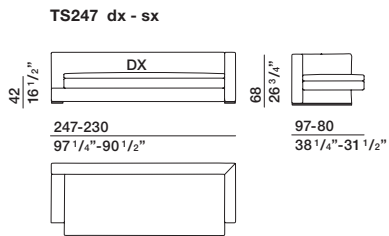

back cushion

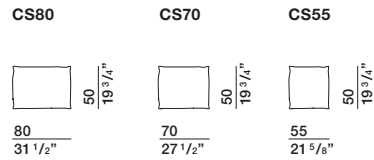

pouf

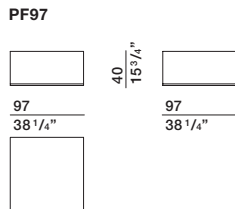

modular pouf

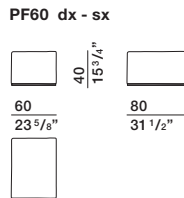

extra cushion

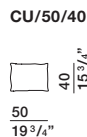

pair of extra cushions

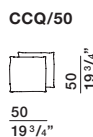

DATASHEET

IX.2018

moltenigroup.com

Dimensions in centimeters and inches. The right to discontinue and make changes is reserved. This information is based on the latest product information available at the time of printing.