

# Molteni & C

## 909 — LUCA MEDA 1997

1—  
4



This is a line of modular chests of drawers whose elements can be used individually or combined to form a large container unit. It's a re-invention of the chest of drawers, standing between the rational and the traditional. A particular version with a refined open compartment with independent lighting and an aluminum structure supporting the drawers.

### DATASHEET

REGISTERED  
DESIGN

IX.2020

## FINISHES

### STRUCTURE FINISHES

matt lacquer colours in the Molteni colour range

### DRAWER FINISHES

matt lacquer colours in the Molteni colour range - glossy lacquer colours in the Molteni colour range

### TOP FINISHES

matt lacquer colours in the Molteni colour range - glossy lacquer colours in the Molteni colour range - eucalyptus - grey oak - graphite oak - coloured glass in the Molteni colour range - etched coloured glass in the Molteni colour range

### OPEN COMPARTMENT/HANDLE/INSERT FINISHES

shiny aluminium - pewter colour

### FEET FINISHES

black chrome - shiny chrome

## TECHNICAL INFORMATION

### STRUCTURE AND FRONT

Wood particleboard with melamine facing painted in the colours available in the “Molteni Range”.

### SIDES AND INTERNAL DRAWER BOTTOM

Particleboard panel, coated with melamine resin.

### HANDLE

In chrome plated or pewter colour painted metal.

### OPEN COMPARTMENT

Frame in extruded glossy or pewter colour anodised aluminium with tempered coloured etched glass (th.4mm). Adjustable metallic feet.

### GLASS TOP

Glass (th. 10mm), tempered coloured extralight or etched and coloured in the colours available in the “Molteni Range”.

### WOODEN TOP

MDF panel veneered with wood – Oak (Quercus), Eucalyptus (Eucalyptus globulus) – or faced with melamine painted in the “Molteni Range” colours.

### ADJUSTABLE FEET

Non-skid plastic material.

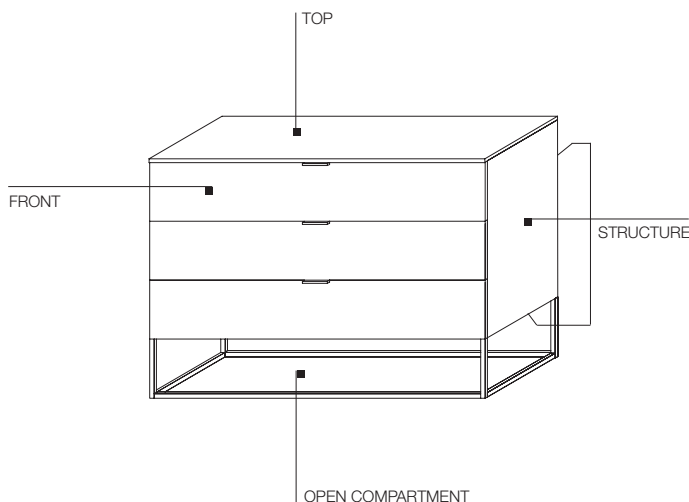

## DATASHEET

REGISTERED  
DESIGN

IX.2020

**DIMENSIONS**

**Notes**

- ▶ The finishing top is compulsory.
- ▶ The glass in the open compartment is always etched and protected.
- ▶ The open compartment is available in pewter colour finish for a supplementary cost.
- ▶ Standard version comes with partially extractable runners.  
Fully extractable runners have a surcharge per drawer.

**drawer unit with 2 drawers**

**NTM4/32 - NTP4/32**

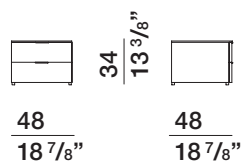

**drawer unit with 2 drawers**

**NTM9/32 - NTP9/32**

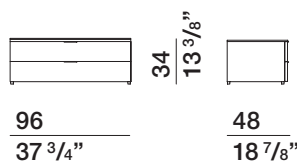

**drawer unit with 3 drawers**

**NTM4/48 - NTP4/48**

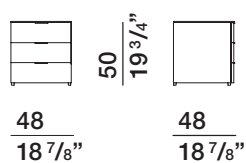

**drawer unit with 3 drawers**

**NTM9/48 - NTP9/48**

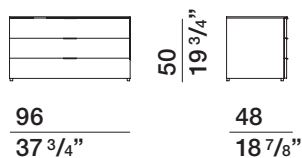

**drawer unit with 1 drawer**

**NCM4/16 - NCP4/16**

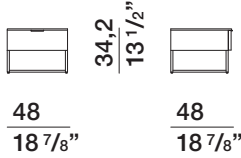

**drawer unit with 1 drawer**

**NCM9/16 - NCP9/16**

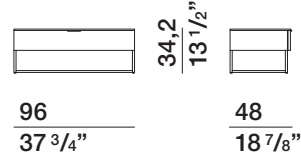

**drawer unit with 2 drawers**

**NCM4/32 - NCP4/32**

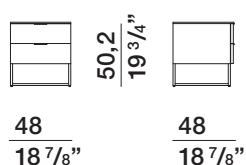

**drawer unit with 2 drawers**

**NCM9/32 - NCP9/32**

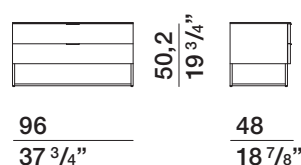

**drawer unit with 3 drawers**

**NCM4/48 - NCP4/48**

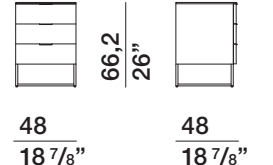

**DATASHEET**

REGISTERED  
DESIGN

IX.2020

**DIMENSIONS**

**drawer unit with 3 drawers**

**NCM9/48 - NCP9/48**

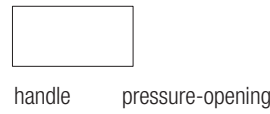
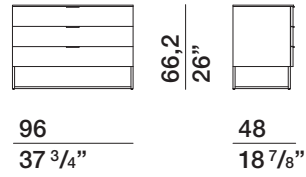

**drawer unit with 3 drawers**

**NTM9/64/3 - NTP9/64/3**

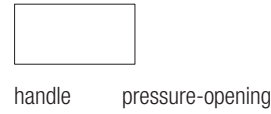
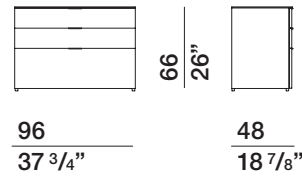

**drawer unit with 4 drawers**

**NTM9/64/4 - NTP9/64/4**

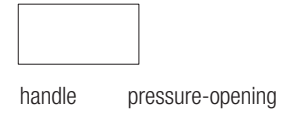
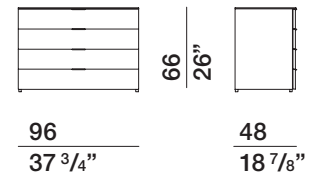

**drawer unit with 5 drawers**

**NTM4/96 - NTP4/96**

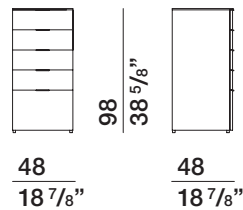

**drawer unit with 5 drawers**

**NTM9/96 - NTP9/96**

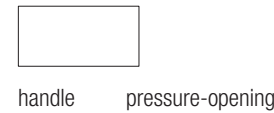
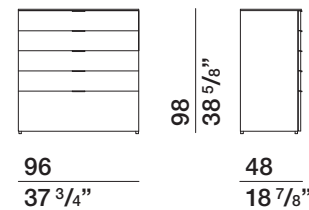

**drawer unit with 3 drawers**

**NCM9/64/3 - NCP9/64/3**

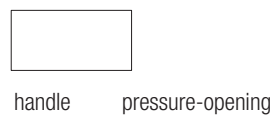
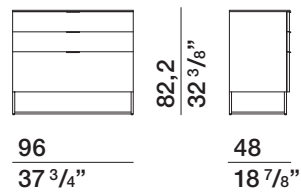

**drawer unit with 4 drawers**

**NCM9/64/4 - NCP9/64/4**

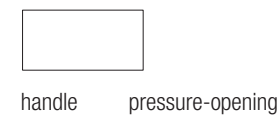
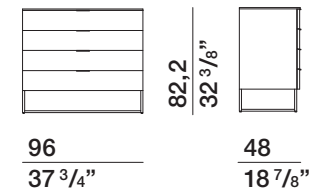

**finishing tops**

D 48,4 th 1  
D 19" th 3/8"



**led lighting system**  
for open compartment

for W 48 18 7/8"



for W 96 37 3/4"

