

Molteni & C

TOUCH DOWN UNIT — STUDIO KLASS 2020 UNIFORM FOR MOLteni&C

1—
4



This small but functional mobile station fits the bill. It can easily follow someone around the home, adapting itself to continuous changes in layout and spatial configuration and to a range of usage modes for working seated on an armchair, office chair or stool, or standing. It acts as a service module, providing a place to store your bag and other personal items, work on a laptop, check your email, answer a message, make a phone call, or charge your devices. The project was in fact created for, and designed around, individual workers who live in different ways each day—and throughout the day—depending on the activity to be carried out.

The mobile unit has a metal structure consisting of a base with a central upright fixed to it. The upright also supports the structure of the worktop, which features vertical and horizontal sliding devices that allow the user to adjust the height and position of the worktop so that it is comfortable and ergonomic for every type of activity. The unit has a compartment where a rechargeable power bank can be inserted. The central structural upright is accessorised also with USB ports where electronic devices can be charged. To facilitate moving the workstation about the office the base is on concealed 360° swivel castors.

DATASHEET

REGISTERED
DESIGN

IX.2021

FINISHES

Finish pairings			
shell	painted dark brown	American walnut *	dark brown hide leather
central body	painted champagne	painted bronze	painted champagne
worktop	American walnut *	American walnut *	American walnut *

* UniFor American walnut finish sample available on request

Molteni & C

2—
4

TECHNICAL INFORMATION

CENTRAL BODY

Structure in painted metal with door designed for electrification.

EXTERNAL SHELL PAINT OR HIDE LEATHER

Plastic that is either painted or covered in hide leather.

EXTERNAL SHELL IN WOOD

Medium density fibreboard panel with solid wood edges, covered in wood veneer.

WORKTOP

American walnut with solid wood edges.

CASTORS

Base fitted with concealed castors with 360° rotation.

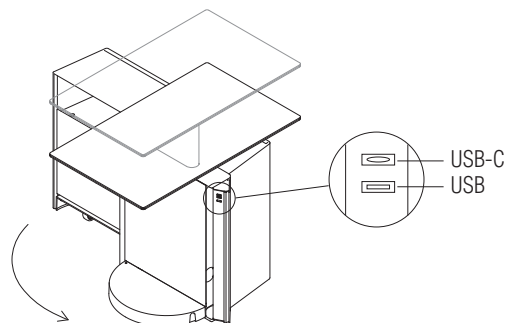

DATASHEET

REGISTERED
DESIGN

IX.2021

DIMENSIONS

Notes

The TDU has a compartment that can contain a power bank.
The power bank is not supplied with the product.
It is advisable to use a power bank with a USB-C power
output and laptop charge capacity.
Max. dimensions for purchasing the power bank:
H 23 x W 7 x D 2,5 cm / H 23 x W 7,5 x D 2 cm
H 9" x W 2 3/4" x D 1" / H 9" x W 3" x D 3/4"

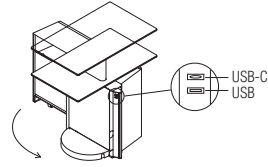

Molteni & C

3—
4

mobile station

PMO1

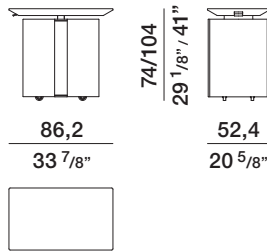

dimensions of internal compartments

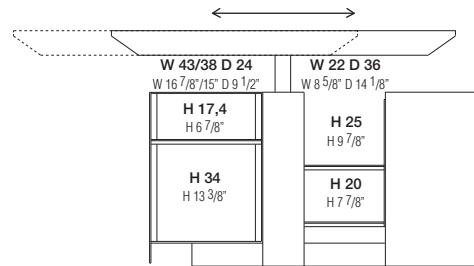

internal fittings

W 22/19 D 24,2
W 8 5/8" / 7 1/2" D 9 1/2"

W 22/19 D 24,2
W 8 5/8" / 7 1/2" D 9 1/2"

W 44/38 D 24,2
W 17 3/8" / 15" D 9 1/2"

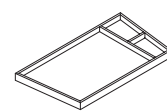
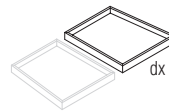
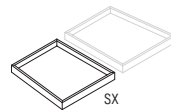

trays

VAS1

VAD1

VA2

dimensions of the different configurations

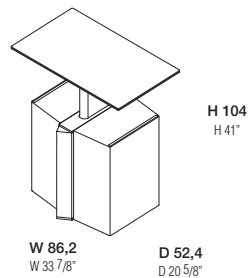
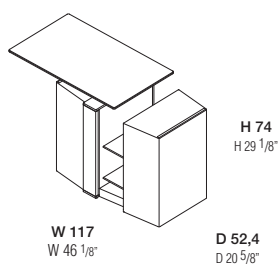
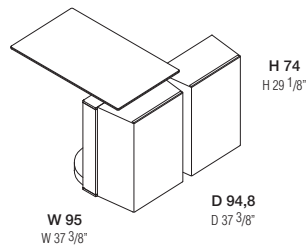
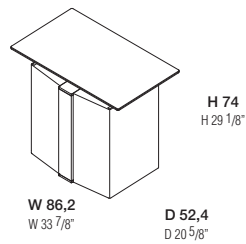

DATASHEET

REGISTERED
DESIGN

IX.2021

DESCRIPTION

Molteni & C

4—
4

- 1 Sliding height adjustable worktop
- 2 Container with horizontal glide opening
- 3 Container with rotational opening
- 4 Auxiliary shelves
- 5 Compartment for personal items
- 6 360° swivel castors
- 7 Power bank compartment



4—
4

4 painted champagne



4 painted dark brown



4 painted bronze



4 dark brown hide leather



4 UniFor American walnut finish

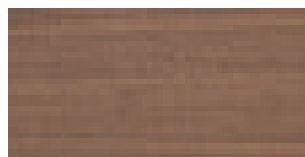

DATASHEET

REGISTERED
DESIGN

IX.2021