

# Molteni & C

## 909 — LUCA MEDA 1991

1—  
4



This is a line of modular chests of drawers whose elements can be used individually or combined to form a large container unit. It's a re-invention of the chest of drawers, standing between the rational and the traditional. Top in coloured glass, wood, glossy lacquered or matt lacquered. Drawers fronts in glossy lacquered or matt lacquered. A particular version with a refined open compartment and an aluminum structure supporting the drawers.

### DATASHEET

REGISTERED  
DESIGN

IX.2018

## FINISHES

### STRUCTURE FINISHES

matt lacquer colours in the Molteni colour range

### DRAWER FINISHES

matt lacquer colours in the Molteni colour range - glossy lacquer colours in the Molteni colour range

### TOP FINISHES

matt lacquer colours in the Molteni colour range - glossy lacquer colours in the Molteni colour range - eucalyptus - grey oak - graphite oak - coloured glass in the Molteni colour range - etched coloured glass in the Molteni colour range

### HANDLE AND INSERT OF THE PRESSURE-OPENING DOORS FINISH

shiny chrome or pewter colour painted

### LEGS FINISHES

black - shiny chrome

## TECHNICAL INFORMATION

### STRUCTURE AND FRONT

Wood particleboard with melamine facing painted in the colours available in the “Molteni Range”.

### SIDES AND INTERNAL DRAWER BOTTOM

Particleboard panel, coated with melamine resin.

### HANDLE

In chrome plated or pewter colour painted metal.

### OPEN COMPARTMENT

Frame in extruded glossy or pewter colour anodised aluminium with tempered coloured etched glass (th.4mm). Adjustable metallic feet.

### GLASS TOP

Glass (th. 10mm), tempered coloured extralight or etched and coloured in the colours available in the “Molteni Range”.

### WOODEN TOP

MDF panel veneered with wood – Oak (Quercus), Eucalyptus (Eucalyptus globulus) – or faced with melamine painted in the “Molteni Range” colours.

### ADJUSTABLE FEET

Non-skid plastic material.

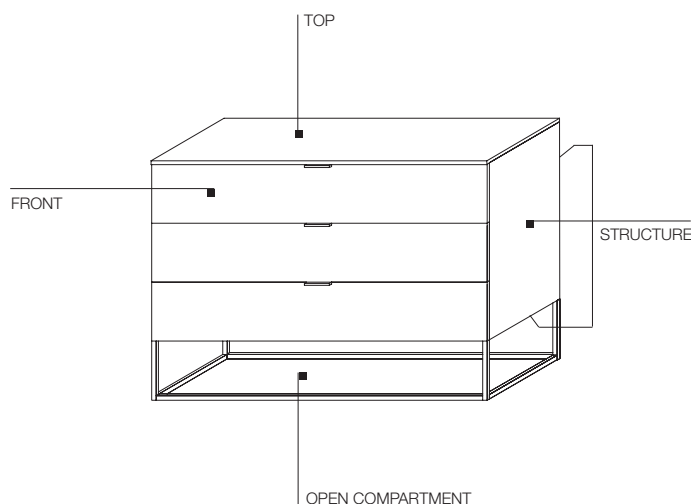

## DATASHEET

REGISTERED  
DESIGN

IX.2018

**DIMENSIONS**

**Notes**

- The finishing top is compulsory.
- Standard version comes with partially extractable runners.
- Fully extractable runners on request.

**drawer unit with 2 drawers**

**NTM4/32 - NTP4/32**

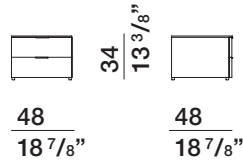

handle

pressure-opening

**drawer unit with 2 drawers**

**NTM9/32 - NTP9/32**

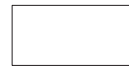
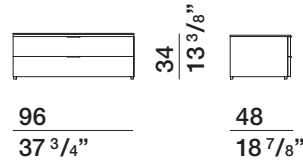

handle

pressure-opening

**drawer unit with 3 drawers**

**NTM4/48 - NTP4/48**

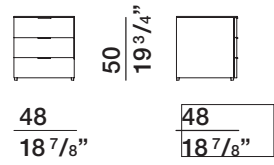

handle

pressure-opening

**drawer unit with 3 drawers**

**NTM9/48 - NTP9/48**

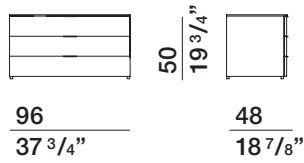

handle

pressure-opening

**drawer unit with 1 drawer**

**NCM4/16 - NCP4/16**

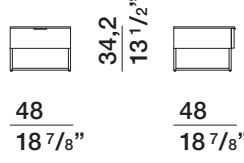

handle

pressure-opening

**drawer unit with 1 drawer**

**NCM9/16 - NCP9/16**

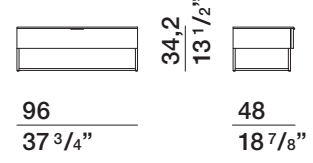

handle

pressure-opening

**drawer unit with 2 drawers**

**NCM4/32 - NCP4/32**

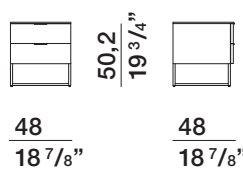

handle

pressure-opening

**drawer unit with 2 drawers**

**NCM9/32 - NCP9/32**

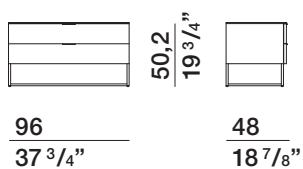

handle

pressure-opening

**drawer unit with 3 drawers**

**NCM4/48 - NCP4/48**

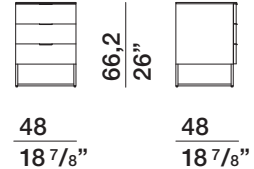

handle

pressure-opening

**DATASHEET**

REGISTERED  
DESIGN

IX.2018

**DIMENSIONS**

**drawer unit with 3 drawers**

**NCM9/48 - NCP9/48**

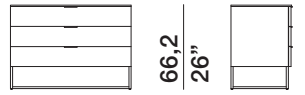

$\frac{96}{37 \frac{3}{4}}$        $\frac{48}{18 \frac{7}{8}}$



handle      pressure-opening

**drawer unit with 3 drawers**

**NTM9/64/3 - NTP9/64/3**

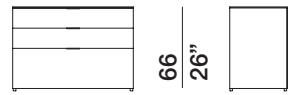

$\frac{96}{37 \frac{3}{4}}$        $\frac{48}{18 \frac{7}{8}}$



handle      pressure-opening

**drawer unit with 4 drawers**

**NTM9/64/4 - NTP9/64/4**



$\frac{96}{37 \frac{3}{4}}$        $\frac{48}{18 \frac{7}{8}}$



handle      pressure-opening

**drawer unit with 5 drawers**

**NTM4/96 - NTP4/96**

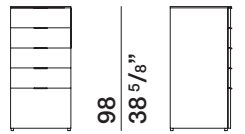

$\frac{48}{18 \frac{7}{8}}$        $\frac{48}{18 \frac{7}{8}}$



handle      pressure-opening

**drawer unit with 5 drawers**

**NTM9/96 - NTP9/96**

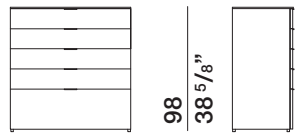

$\frac{96}{37 \frac{3}{4}}$        $\frac{48}{18 \frac{7}{8}}$



handle      pressure-opening

**drawer unit with 3 drawers**

**NCM9/64/3 - NCP9/64/3**

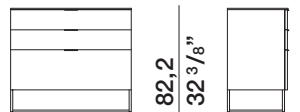

$\frac{96}{37 \frac{3}{4}}$        $\frac{48}{18 \frac{7}{8}}$



handle      pressure-opening

**drawer unit with 4 drawers**

**NCM9/64/4 - NCP9/64/4**

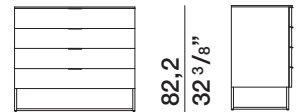

$\frac{96}{37 \frac{3}{4}}$        $\frac{48}{18 \frac{7}{8}}$



handle      pressure-opening

**led lighting system**  
for open compartment

for W 48 18 7/8"



**HLG48**

for W 96 37 3/4"

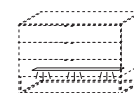

**HLG96**

**finishing tops**

D 48,4 th 1  
D 19" th 3/8"



**T0Q48**



**T0Q96**

**Molteni & C**

**FINISHES  
MOLTENI&C  
RANGE**  
IX.2018

	MATT LACQUER	GLOSSY LACQUER	COLOURED GLASS	ETCHED COLOURED GLASS	CARTAPAGLIA LACQUERED only Gliss Master	STOPSOL GLASS TRANSPARENT STOPSOL GLASS
CHALK WHITE	•	•	•	•	•	
PEARL	•	•	•	•	•	
SILICA	•	•	•	•	•	
SAND	•	•	•	•	•	
DOVE GREY	•	•	•	•	•	
PLATINUM	•	•	•	•	•	
DUNE	•	•	•	•	•	
CLAY	•	•	•	•	•	
DOLOMITE GREY	•	•	•	•	•	
COPPER	•	•	•	•	•	
RUST	•	•	•	•	•	
RUBY	•	•	•	•	•	
CARAMEL	•	•	•	•	•	
MOKA	•	•	•	•	•	
MUSTARD	•	•	•	•	•	
LIGHT BLUE GREY	•	•	•	•	•	
PEWTER COLOUR	•	•	•	•	•	
ANTHRACITE	•	•	•	•	•	
BLACK	•	•	•	•	•	
STOPSOL						•
LESSLESS RED	•					
only matt lacquer						

The finishes shown are indicative and refer to the entire production range. We recommend that you consult the "Colour Range" samples which show the complete range of finishes, including those not shown here. Molteni&C reserves the right to modify the range without warning.

**WOODS**

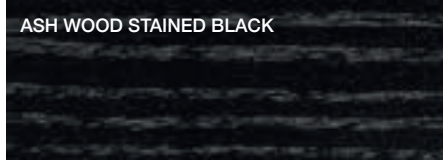
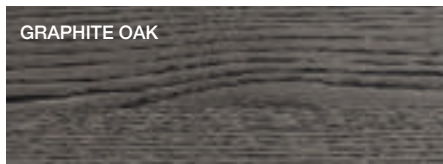
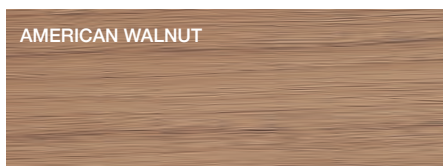
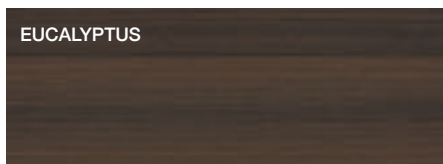

**MARBLES**

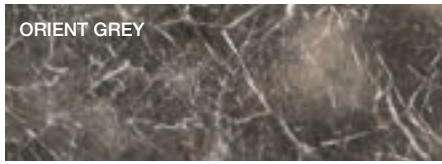
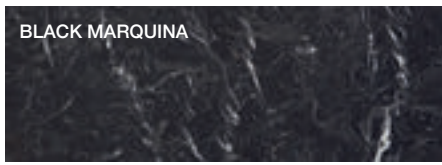
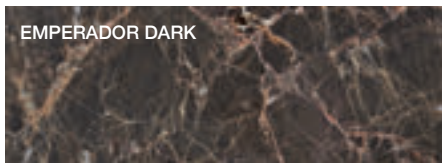
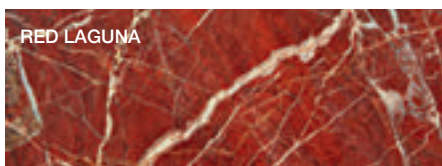
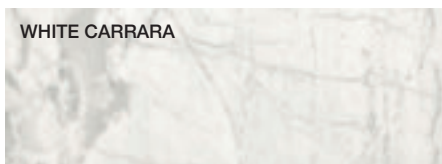

**METAL PARTS**

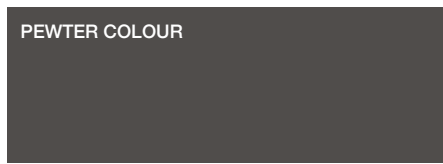
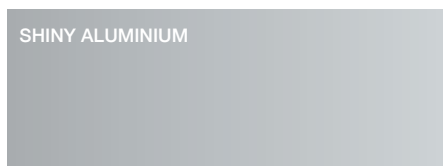

**DWELL**  
DOOR FRAME, TRACK COVERING PROFILES

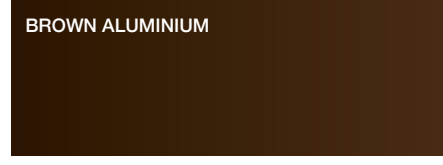

**MELAMINE FRONT**  
GLISS MASTER

CARTAPAGLIA WHITE

CARTAPAGLIA ANTHRACITE

CARTAPAGLIA SILICA

GRAFFIATO SILICA

GRAFFIATO BRONZE

SILK DOVE GREY

SILK SILICA

SILK CHALK WHITE

**MELAMINE STRUCTURE**  
GLISS MASTER

WHITE SHANTUNG

GREY SHANTUNG

**MELAMINE STRUCTURE**  
GLISS MASTER, MASTER DRESSING,  
GLISS WALK-IN

SILVER CEMBRAN

LARIX DARK

**MELAMINE STRUCTURE**  
GLISS MASTER, MASTER DRESSING

WHITE

**ECO SKIN**

IVORY

HEMP

MINK

DARK BROWN

GREY

**FINE GRAIN**

FINE GRAIN